

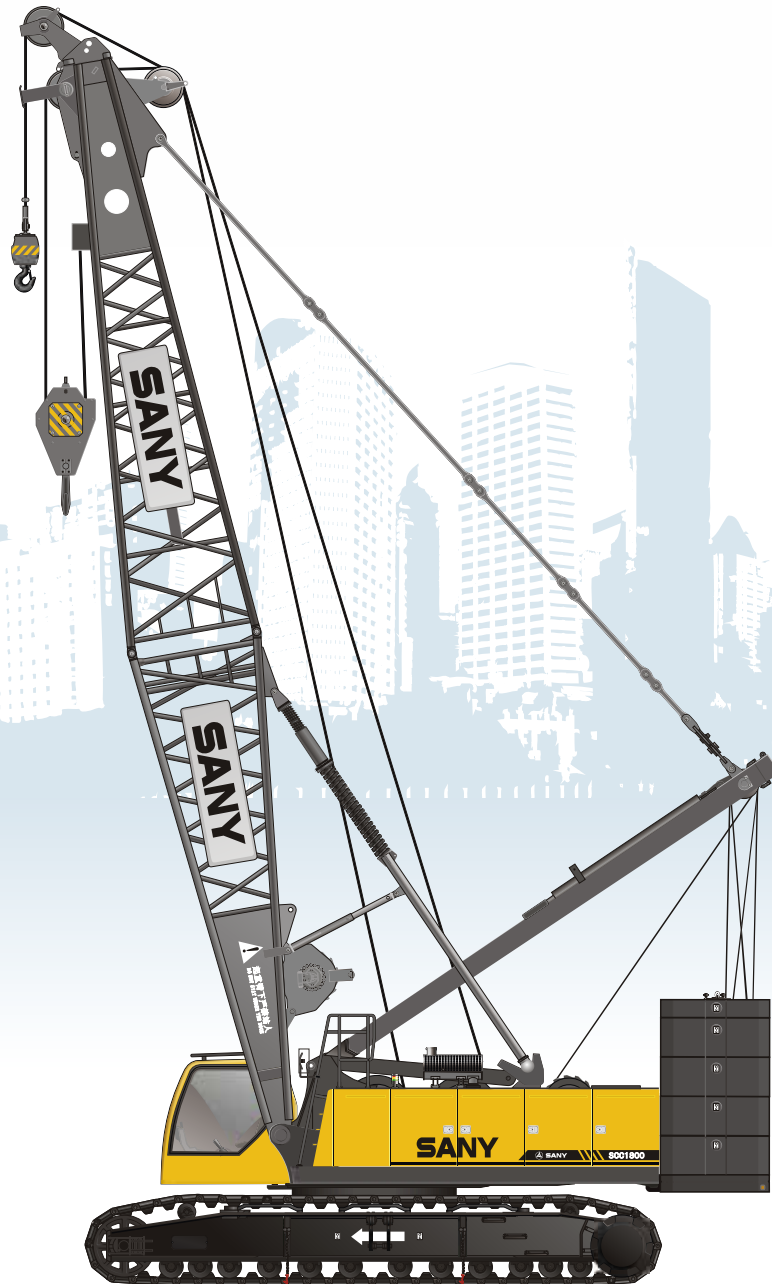

SANY

Quality Changes the World



SANY CRAWLER CRANE SCC 1800

CRAWLER CRANE

CONTENTS

P3

SCC1800 Crawler Crane

- Outline Dimensions
- Main Technical Features
- Performance Data
- Transport Dimensions
- Assembly Diagram

P14

Specifications

- Superstructure
- Undercarriage
- Operation Devices
- Safety Devices
- Main Parameters

P23

Operating Condition Combinationns

- Operating Condition
- H_L Operating Condition
- H Operating Condition
- LJ Operating Condition
- FJ Operating Condition

SCC1800

04	Outline Dimensions
05	Main Technical Features
06	Performance Data
07	Transport Dimensions
11	Assembly Diagram

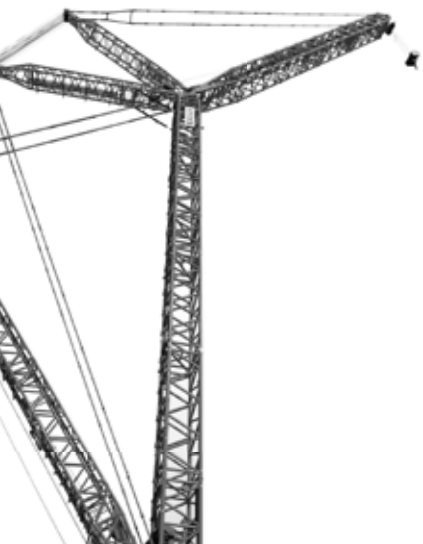

OUTLINE DIMENSIONS

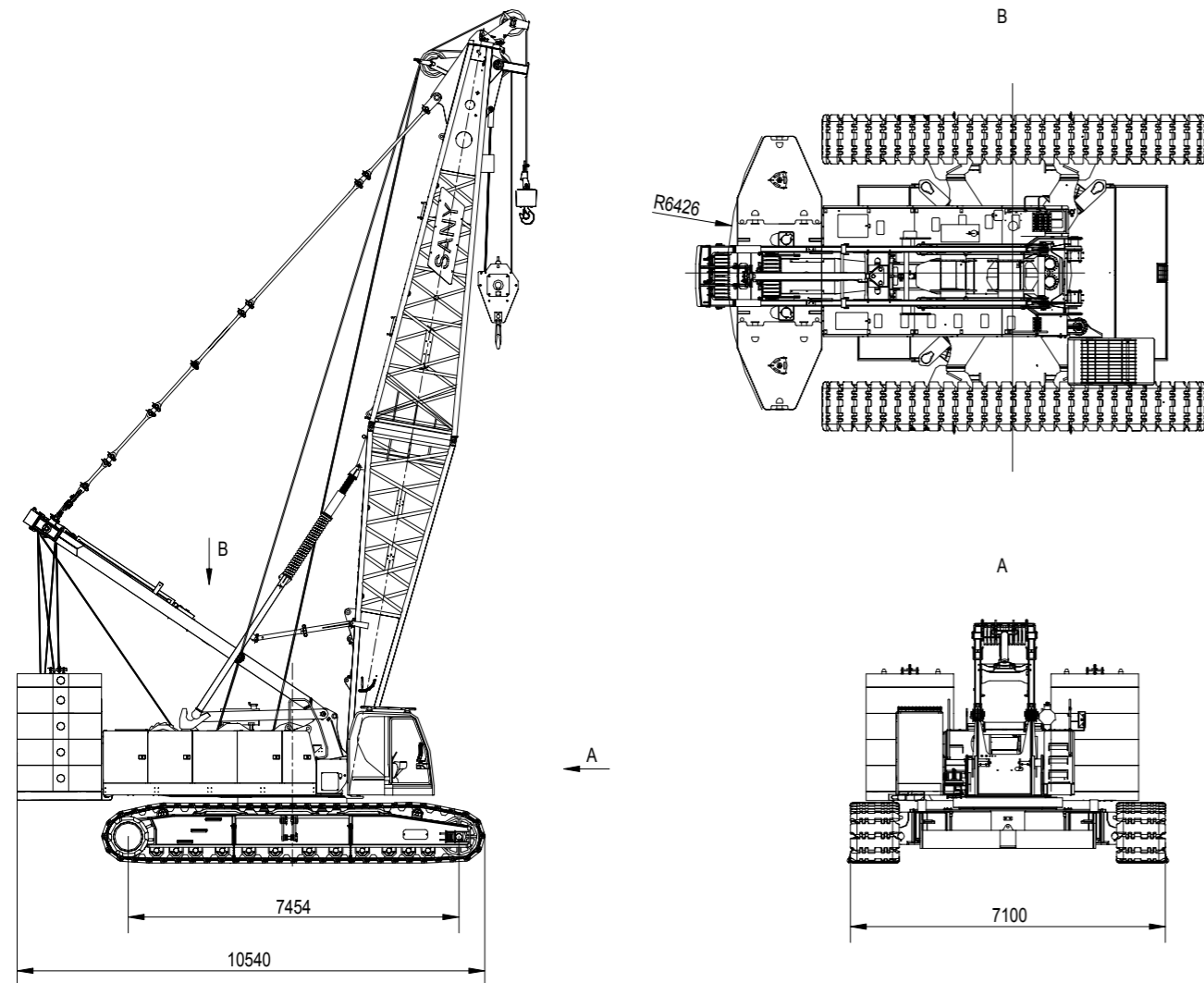

MAIN TECHNICAL FEATURES

1. Safety Control System:

There are two operation modes, working and installation for your convenience. It features with real-time level display, stop operation braking away from machine, emergency electrical control, anti-lightning protection, automatically walk switches and CCTV with a complete set of safety and monitoring devices;

2. Excellent Operating Performance:

Load-sensing, limit load regulation and electro-hydraulic proportional micro-speed control make each micro-movement extremely smooth and operation more stable;

3. Reliable Functions Assurance:

The safety margin in structural design is sufficient and the control system is fully capable to function stably in extreme environments such as cold, high temperature, altitude and sandy conditions.

4. Convenient Maintenance Technology:

It takes approximately no more than 10min/person to adjust;no more than 30min/person for daily maintenance;no more than 2h/person to repair.GPS remote monitoring system is optional for maintenance and management.;

5. Powerful Lifting Capacity:

The maximum lifting capacity of boom is $132t \times 8m = 1056t \cdot m$, the longest boom is 85m, The maximum lifting capacity of luffing jib is $48.7t \times 14m = 682t \cdot m$, the longest boom + jib is 53m+52m; it can support up to 5 operating conditions;

6. Efficient Self Assembly and Disassembly Technology:

The whole machine can be assembled and disassembled by itself, and the assembly of basic machine only requires 3h; the patented synchronic control technology of one-key lifted mast has independent intellectual property right;

7. Optimized Transport Programs:

The transportation width of basic machine is only 3m, with a transportation weight of 43.5t, so it can be transported around the world without limitation;

8. Large Chassis Design:

6m gauge chassis ensures excellent machine and job operation stability within the range of 360° rotation;

9. Automatic Traveling Direction:

The crane may travel forward through automatic adjustment after rotating 180° ;

10. Fuel Heater (Optional):

Engine can work under low temperature in extremely cold areas;

11. Two-stage Engine Filter:

Enable the use of home-made diesel;

12. 100% Load Travel:

Powerful tracking force and travel smoothness bring the advantages of crawler crane into full play;

13. Broad Adaptability:

Meet the certification requirement of Europe, North America, Australia, Russia and Taiwan; the engine emission complies with the European and U.S. Non-highway Stage Tier 3 Standards.

PERFORMANCE DATA

Main performance data of SCC1800 crawler crane			
Performance index		Unit	Parameter
Boom H operating conditions	Max. rated lifting capacity	t	180
	Boom length	m	16~85
	Boom luffing angle	°	30~80
Fixed jib FJ operating conditions	Fully extended boom + fully extended fixed jib	m	70+31
	Fixed jib offset angle	°	10, 30
Luffing jib LJ operating conditions	Max. rated lifting moment	t·m	48.7×14
	Fully extended boom + fully extended luffing jib	m	53+52
	Boom luffing angle	°	65~85
	Jib luffing angle	°	15~75
Speed parameters	Rope speed of main (auxiliary) winch (outermost working layer)	m/min	0~125
	Rope speed of main luffing winch (outermost working layer)	m/min	(0~24) × 2
	Rope speed of auxiliary luffing winch (outermost working layer)	m/min	0~24
	Swing speed	rpm	0~2
	Travel Speed	km/h	0~1.2/0~0.6 (two-speed)
	Gradeability	%	30
Engine	Output power/rated speed	kW/rpm	242 /2100
Transportation parameters	Maximum transport weight of single piece	t	43.5
	Transport dimensions (length X width X height)	mm	10130×3000×3200
	Average ground pressure	MPa	0.1

TRANSPORT DIMENSIONS

Basic Machine	×1
Length	10.13m
Width	3.00m
Height	3.20m
Weight	43.5t
Crawler Assembly	×2
Length	8.63m
Width	1.47m
Height	1.17m
Weight	20t
Boom Tip	×1
Length	9.26m
Width	2.21m
Height	2.49m
Weight	3.1t
Boom Base	×1
Length	8.07m
Width	2.23m
Height	2.91m
Weight	4.4t
Boom Base (including winch)	×1
Length	8.07m
Width	2.23m
Height	2.91m
Weight	6.3t
3m Boom Insert	×1
Length	3.13m
Width	2.23m
Height	2.01m
Weight	0.81t
6m Boom Insert	×3
Length	6.14m
Width	2.30m
Height	2.01m
Weight	1.3t

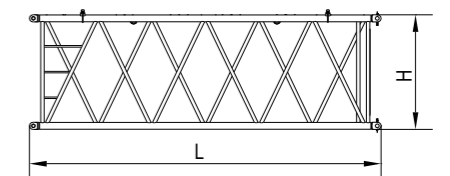
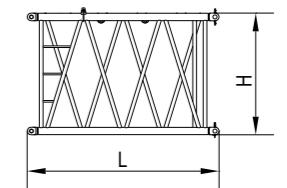
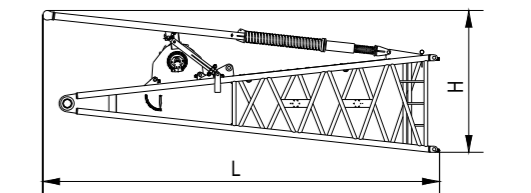
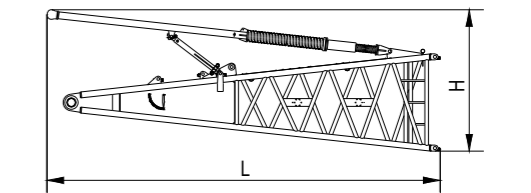
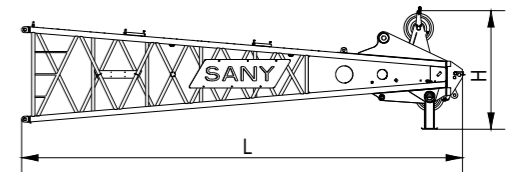
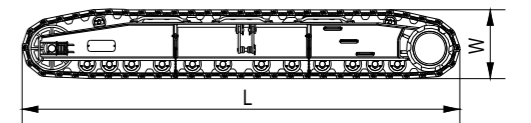
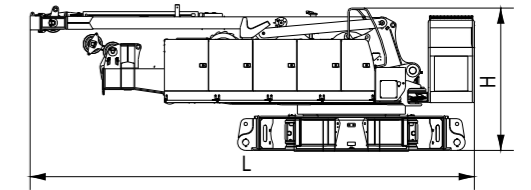

TRANSPORT DIMENSIONS

12m Boom Insert	×4
Length	12.14m
Width	2.30m
Height	2.01m
Weight	2.2t
Transitional Section	×1
Length	6.13m
Width	2.23m
Height	2.55m
Weight	1.6t
Fixed Jib Tip	×1
Length	5.48m
Width	1.02m
Height	0.85m
Weight	0.47t
Fixed Jib Base	×1
Length	5.19m
Width	1.02m
Height	0.85m
Weight	0.27t
3m Fixed Jib Insert	×1
Length	3.08m
Width	1.02m
Height	0.85m
Weight	0.12t
6m Fixed Jib Insert	×3
Length	6.08m
Width	1.02m
Height	0.85m
Weight	0.28t
Boom Extension	×1
Length	1.12m
Width	0.45m
Height	0.82m
Weight	0.21t

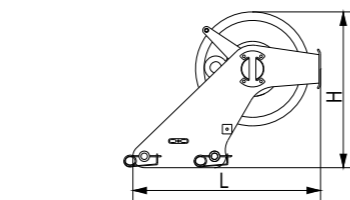
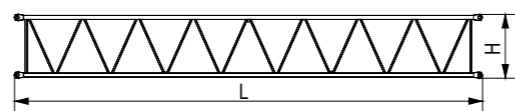
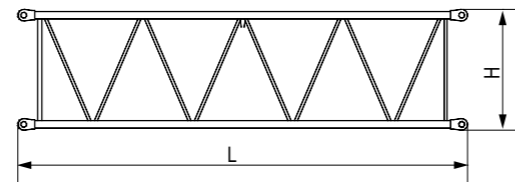
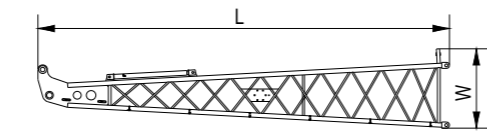
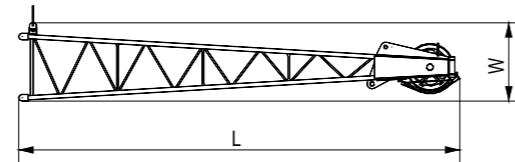
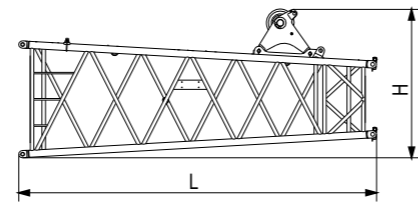
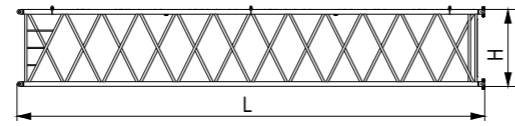

TRANSPORT DIMENSIONS

Fixed Jib Strut	×1
Length	5.46m
Width	1.05m
Height	0.60m
Weight	0.52t
Tower Operating Condition Combination	×1
Length	10.81m
Width	1.79m
Height	2.87m
Weight	7.1t
Luffing Jib Tip (including boom extension)	×1
Length	7.02m
Width	1.50m
Height	1.42m
Weight	1.31t
6m Luffing Jib	×2
Length	6.11m
Width	1.50m
Height	1.31m
Weight	0.55t
12m Luffing Jib	×2
Length	12.08m
Width	1.50m
Height	1.31m
Weight	1.2t
Counterweight Tray	×1
Length	6.14m
Width	1.90m
Height	0.62m
Weight	9t
5.5t Counterweight	×10
Length	1.97m
Width	1.90m
Height	0.69m
Weight	5.5t

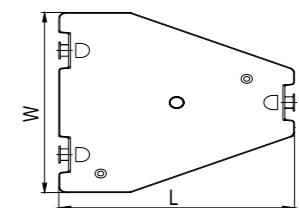
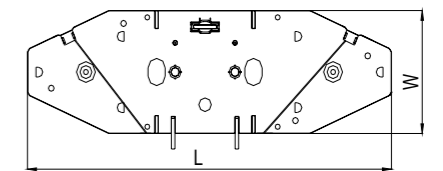
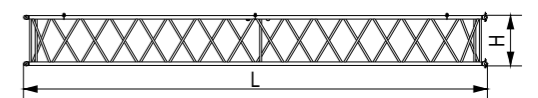
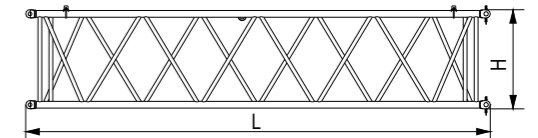
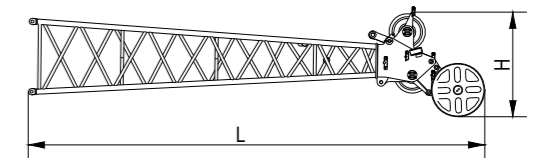
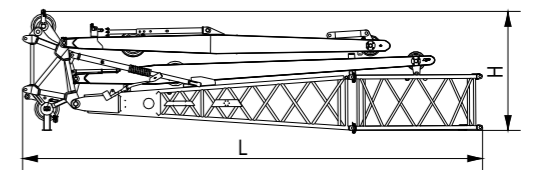
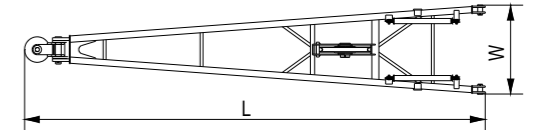

TRANSPORT DIMENSIONS

Central Counterweight	×2
Length	3.95m
Width	1.44m
Height	0.73m
Weight	10.0t
200t Lifting Hook	×1
Length	0.91m
Width	1.20m
Height	2.44m
Weight	3.83 t
150t Lifting Hook	×1
Length	0.89m
Width	1.03m
Height	2.23m
Weight	2.80 t
100t Lifting Hook	×1
Length	0.93m
Width	0.84m
Height	2.36m
Weight	1.99 t
50t Hook Block	×1
Length	0.89m
Width	0.47m
Height	1.95m
Weight	1.06t
25t Ball Hook	×1
Length	0.90m
Width	0.37m
Height	1.87m
Weight	0.79 t
13.5t Hook Block	×1
Length	0.50m
Width	0.50m
Height	0.95m
Weight	0.53 t

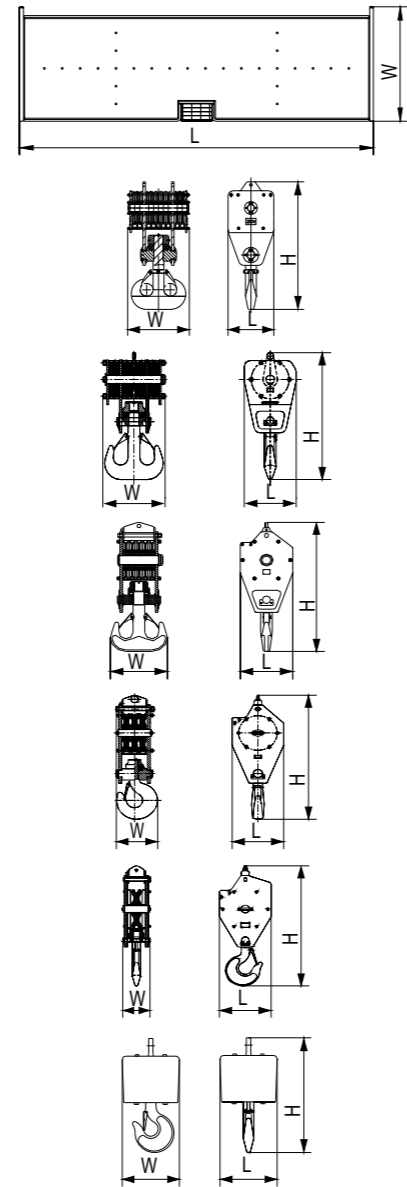

Notes: 1.The transport dimensions of the parts are marked on schematic diagrams, but not drawn by scale; the dimensions indicated are the design values excluding package.
2.Tiny difference(±2%)

ASSEMBLY DIAGRAM

The crane is provided with functions of self-assembly/ disassembly, e.g. crawler traveling tracks(optional) , central counterweight (optional), rear counterweight of basic machine (optional) and boom base (optional) can all be self-assembled/ disassembled. In the process of assembly, the crawler traveling

tracks shall be first assembled, then central counterweight, rear counterweight of basic machine and base. Reverse the order in the process of disassembly, and see the figure below for specific operation process (as for disassembly, reverse the procedure).

1) Installation of crawler

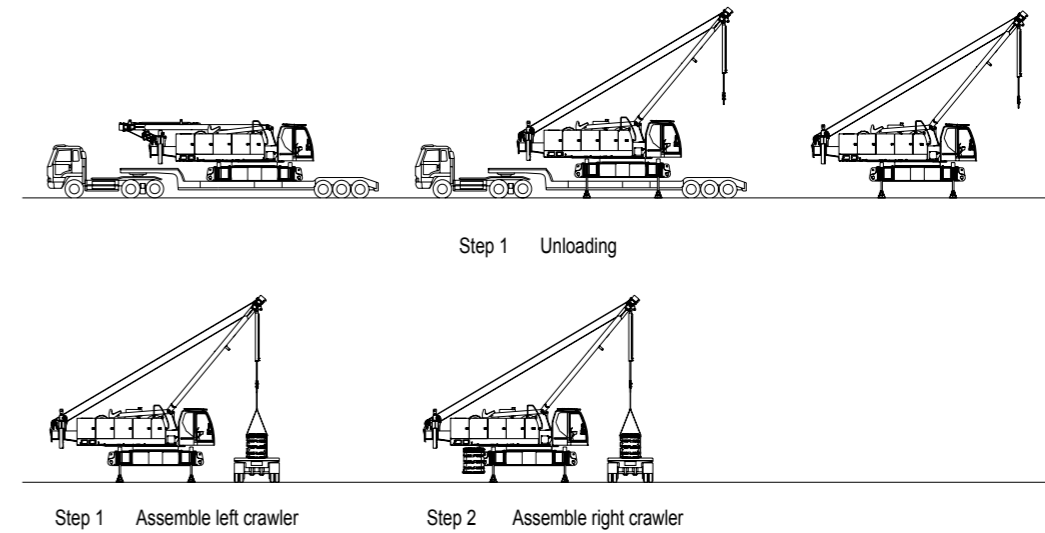

2) Installation of counterweight

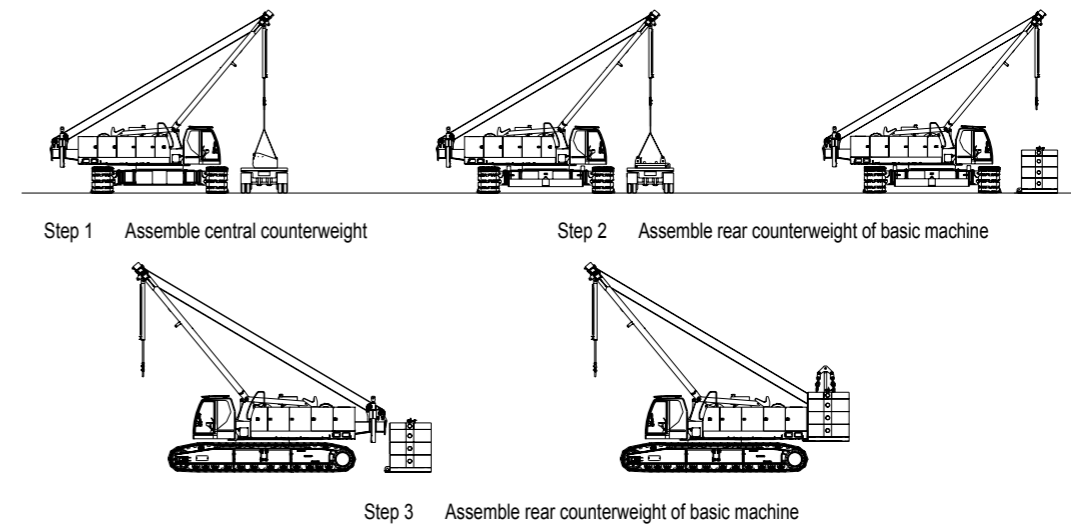

ASSEMBLY DIAGRAM

3) Installation of boom base

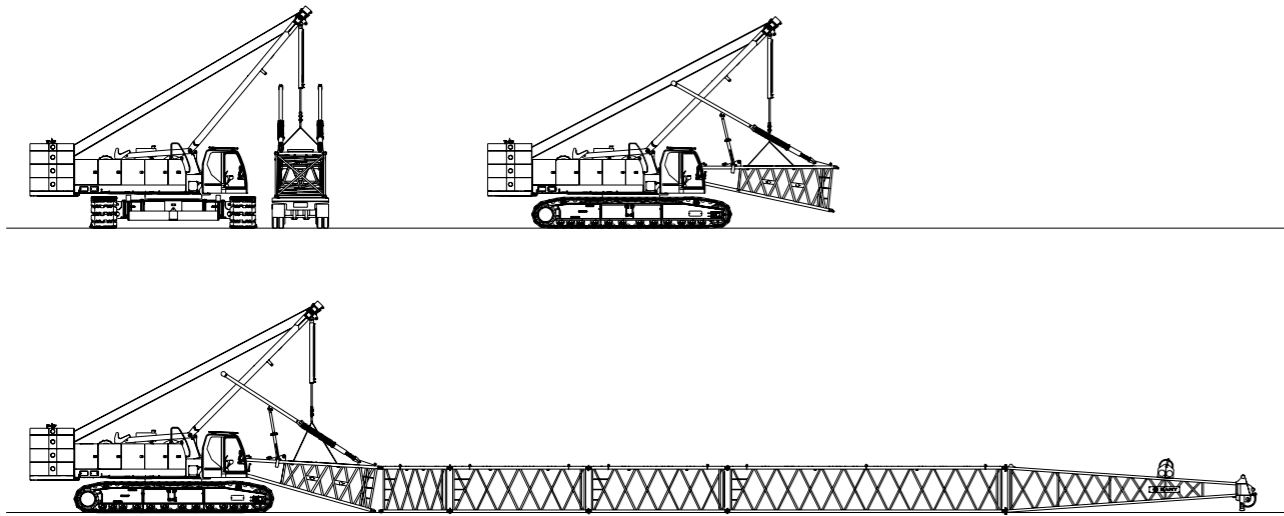

Assembly diagram of boom base

4) Installation of fixed jib

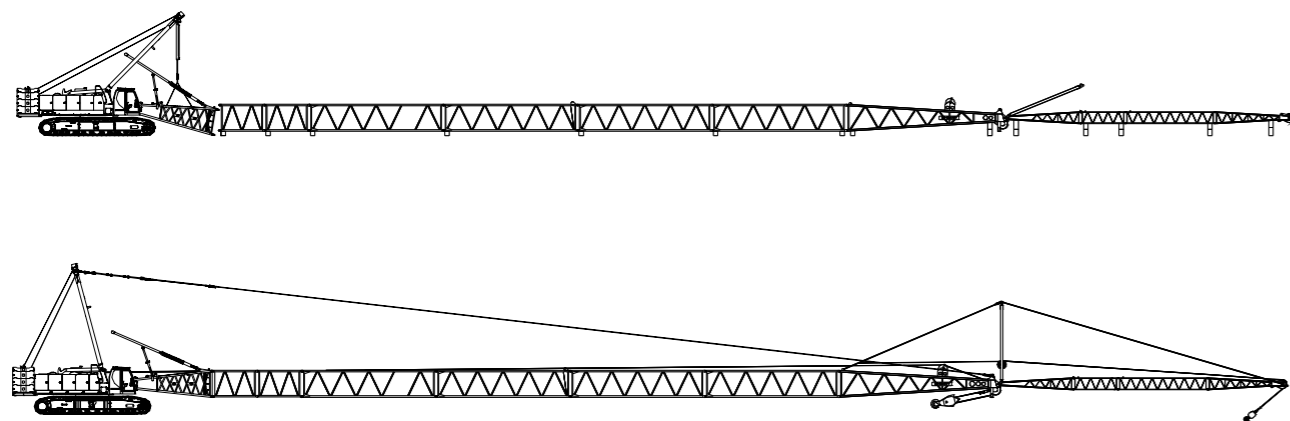

Assembly diagram of fixed jib

ASSEMBLY DIAGRAM

5) Installation of luffing jib

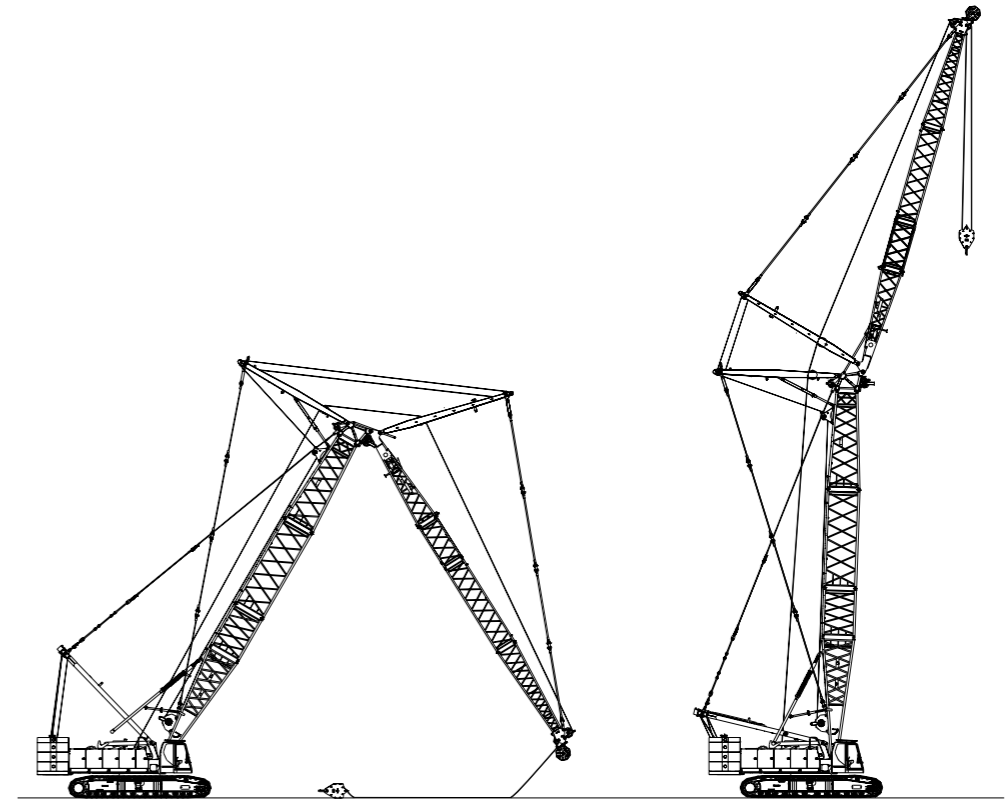
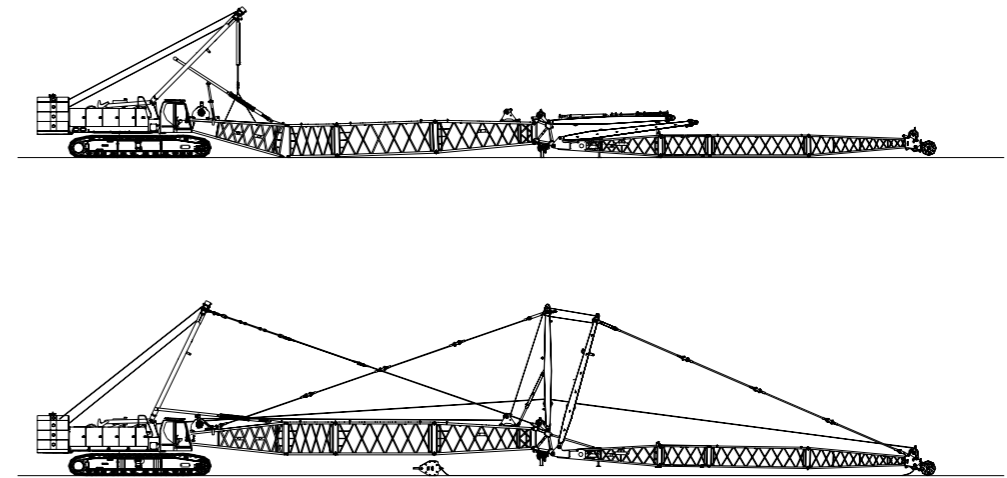

Assembly diagram of luffing jib

SCC1800

Superstructure	15
Undercarriage	17
Operation Devices	18
Safety Devices	19
Main Parameters	22

SUPERSTRUCTURE

1) Engine

- American Cummins:
Rated power/speed: 242kW/2100rpm.
Maximum torque: 1424N·m/1500rpm.
Emission standards: Tier 3.
- Dongfeng Cummins:
Rated power/speed: 242kW/2100rpm.
Maximum torque: 1385N·m/1500rpm.
Emission standards: Tier 3.
- Air filter: double filtration system compose of air pre-filter and air filter.
- Fuel tank: 400L with fuel indicator and digital display

2) Hydraulic System

- Configuration of hydraulic system: adopt advanced hydraulic systems, including the main pump, main valve, control handle joystick and motor reducer. It is efficient, energy saving, stable and reliable.
- It has excellent micro-rotation and performance improvement. The load sensing and limit load adjustment make operation more stable.
- Adopt independently controlled hydraulic oil cooling system.

3) Main and Aux. Hoist Drums

- Main and auxiliary lifting mechanism are independently driven and easy to install. The built-in, wet type braking is of low abrasion and maintenance-free, which ensures the safety of the winches.
- High quality motor reducer and steel wire are adopted for higher safety, reliability and durability.
- The maximum winch speed can be achieved through automatic displacement adjustment by variable hydraulic motor.

NO.1 Main hoisting winch

Drum diameter	596mm
Rope speed of the outermost working layer	0~125m/min
Diameter of wire rope	26mm
Wire rope length of main winch	390m
Rated single rope tension	13.4t
Specification of wire rope	Right-hand rotary concurrent twist

NO.2 Auxiliary hoisting winch

Diameter of steel wire	596mm
Wire speed of outer operating wires	0~125m/min
Wire rope diameter	26mm
Steel wire length of auxiliary lifting mechanism	300m
Rated tension of single wire	13.4t
Specification of steel wire	Right-hand rotary concurrent twist

4) Swing Mechanism

- It is driven by swing motor and buffered hydraulically to provide 360° rotation.
- Brake: Normally closed, embedded, wet type, and spring disc-type brake, with spring force braking and oil pressure releasing.
- Slewing lock: Slewing lock device is employed to avoid impact on the slewing upper part during the load traveling and transportation.
- Slewing ring: 3-rows roller column type slewing ring.
- Swing speed: 0-2.0r/min.

5) Main and Auxiliary Luffing Mechanisms

The main luffing mechanism adopts tandem drum.

NO.3 Main luffing winch

Drum diameter	460mm
Wire speed of outer operating wires	(0~24)×2 m/min
Wire diameter	20mm
Wire length of main luffing winch	320m
Rated single rope tension	9.73t
Specification of wire	Right-rotary alternating twist

NO.4 Auxiliary luffing winch

Drum diameter	470mm
Wire speed of outer operating wires	0~24m/min
Wire diameter	20mm
Wire length of auxiliary luffing winch	240m
Rated single rope tension	6.15t
Specification of wire	Right-rotary alternating twist

6) Counterweight

Name	Q' ty	Single piece weight (kg)	Total weight (kg)
Counterweight block	10	5500	44000
Tray	1	9000	9000
Central counterweight Block	2	10000	20000
Total weight of all counterweights Block (kg)			84000

7) Cab

- SANY' s new ergonomically designed and manufactured fully enclosed cab with adjustable seat and well ventilated air conditioning provides the operator with a comfortable working environment.
- Four near and far beam light.
- Lager-are windows and more open vision.
- The adjustable armrest box can move forwards and backwards with the seat.
- The driver' s cab can be adjusted according to the operating needs, capable of realizing moving up and down 20° and rotating to the right front of platform.
- The pitching cab broadens the operation vision of the driver, improving the safety in operation; it can be rotated so as to reduce the transportation width.

8) Control Operation

- All actions of the crawler travel unit are controlled by the traveling pedal (control lever). The left traveling pedal (control lever) drives the left crawler while the right traveling pedal (control lever) drives the right crawler. The engine speed is controlled by the foot throttle or hand throttle and the start switch is located on the right armrest box. The joystick of main luffing and main winch are located on the right armrest box while the control handles of auxiliary winch, auxiliary luffing/swing control handles on the left armrest box. To the right front of seat is the auxiliary control box, on the control panel of which all switches are operated manually to realize corresponding functions.
- The operation of traveling pedal (control lever) has the function of automatic direction adjustment, that is, which makes the operation direction always the front direction of the operator.

UNDERCARRIAGE

1) Crawler Travel

All crawler frames are equipped with independent traveling drive. The hydraulic traveling motor drives planet gear reducer to achieve independent traveling through the transmission of the driving wheel.

2) Travelling Brake

Built-in, normally closed disk brake. When operating pedal is not pushed, the machine is braked and is able to compensate automatically without adjustment. When it is pushed, it will be released and start traveling.

3) Track Shoes

There are 112 track shoes for left and right track travelling device, with the width of 1100mm for each shoe. The tension of track shoe can be adjusted to ideal state by adjusting the location of shims with hydraulic jack.

4) Chassis

- The hydraulic cylinder drive power pin is connected with track frame for easy assembly and disassembly. The chassis is of high-strength steel welded frame structure.
- The large chassis design improves the stability of the whole machine.
- The weight of undercarriage counterweight is 20t, with 10t distributed at front and rear, which is capable of the self assembly.

5) Travelling speed

- Low speed: 0.6 km/h
- High speed: 1.2 km/h

OPERATION DEVICES

1) Boom

- Lattice structures;the main chord adopts high strength structure steel;each section is connected with pins.
- Standard boom sections include: base 7.5m, tip 8.5m, insert 3m×1, insert 6m×3, and insert 12m×4.
- The boom length is between 16m, the basic boom length and 85m, the max. length, which increases and decreases by every 3m.

2) Luffing Jib

- Lattice structures;the main chord adopts high strength structure steel;each section is connected with pins.
- Luffing jib sections include: tip 6.5m, base 6.5m, insert 3m×1, insert 6m×2, and insert 12m×2; it can mounted onto the boom of 23m~53m long. The luffing jib available ranges 22m~52m long.

3) Heavy-duty Boom

- The boom is truss structure with uniform section in the middle and variable sections at both ends. It is welded with steel tubes, and the top and root segment of arm support are reinforced with steel plates, which is favorable to transmit loads.
- Heavy-duty boom sections include: base 7.5m, reducing arm 6m, arm head 0.5m, insert 3m×1, insert 6m×3, and insert 12m×3.
- The heavy-duty boom length is between the basic boom 23m and the maximum length 71m, taking 3m as a step.

4) Fixed Jib

- The boom is of lattice structure with uniform section in the middle and variable sections at both ends. It is welded with steel tubes, and the top and root segment of arm support are reinforced with steel plates, which is favorable to transmit loads.
- The fixed jib can be mounted onto the boom with the length of 28m~70m, including tip 5m, base 5m, insert (length x quantity): 3m×1, 6m×3; and available jibs are respectively 13m, 19m, 25m, and 31m long.
- Fully extended boom + fully extended jib: 70m + 31m.

5) Boom Extension

It is a welded structure with pulley on the tip and connects with boom through pin.

6) Hooks

- Standard configuration:

200t	lifting hook
150t	lifting hook
50t	lifting hook
13.5t	lifting hook
- Optional:

25t	lifting hook
100t	lifting hook

Notes: The above operating devices are safe configuration: order contract shall prevail for specific configuration.

SAFETY DEVICES

1) Load Moment Indicator (LMI)

As the independent safety control system fully controlled by computer, the load moment indicator can automatically detect the load weight, working radius and lifting boom angle, to compare with the corresponding rated parameters. Moreover, under normal operation condition, it can intelligently detect and automatically cut off the crane action to dangerous direction, and have the black box function to record the over-load information.

2) Three-color Alarm Light

Corresponding with the load displayed on LMI to show safety condition of the lifting device.

3) Main and Auxiliary Hoisting Limiter

Composed of limit switch, hammer etc. on jib to prevent excessive promotion of hook block. When the lifting hook raises to a certain height, limit switch will work, the buzzer on the control panel will alarm, meanwhile the failure indicator blinks and automatically stop the lifting operation of hook block.

4) Lowering Limiter of Main and Auxiliary Winch

Composed of movement trigger device and proximity switches to prevent wire rope from being. When the wire rope is over-decentralized near the last three hoops, limit switch will work, the system will alarm through buzzer, alarm information will be displayed in instrument cluster and automatically stop the decentralization movement of hoist.

5) Assembly/Operation Mode Change -Over Switch

In assembly mode, the over-hoist limit device, boom angle limit device and LMI will be bypassed for the assembly of crane.

In operation mode, all safety limit devices are able to work.

6) One-key Lifted Boom Luffing Mast

The boom luffing masts can be lifted and dropped in synchronization with the rolling-out and rolling-in of boom luffing winches.

7) Boom Angle Limiter

Depending on the operating conditions, the crane's boom or jib can operate within the safety angles limited by the mechanical limit and the force limiting system.

8) Boom Back Stop Device

- It is of steel pipe structure, with the compression force of spring as supporting force to prevent the boom from tilting backwards.
- There is a set of mechanical back stop device on the luffing jib mast to prevent the mast from titling backwards.
- If the angle between the jib and the extension line of boom is 10°, the mechanical back stop device will be activated to prevent it roll over backwards.

9) Winch Brake

All winch brakes are spring-loaded normal-engaged disk brakes, which provide a big braking force and are safe, reliable, free of maintenance, and durable.

10) CCTV Monitoring System

The high-definition camera is used to monitor the real-time status of the luffing drum, hoisting winch and vehicle rear.

11) Self-Diagnosis System

It can automatically give the fault and alarm information and check the electrical circuit for working power state for the rapid elimination of electrical faults.

12) Pharos

Installed on the top of arm rest; provide instructions for boom at height.

13) Anemometer

Installed at the top of boom supporter for real-time monitoring of wind speed; and transmit the data to driver's cab and display on monitor.

14) Level Gauge

Based on the bubble level gauge as the calibration reference, the electric level gauge can show the tilt angle of crane precisely in real time and alerts safety working ground environment.

15) Boom Angle Indicator

Pendulum angle indicator device is located in boom base next to the cab for operator convenience.

16) Hook Latch

There is a baffle on the hook to prevent the wire rope fall off.

17) Real-time Display of Ground Pressure (Optional)

The following information is instantly calculated according the operation state of crane, distribution trend of pressure, effective ground contact length, average and max. ground pressure from crawler to ground, ground pressure at every key point, and eccentricity of crane gravity center, etc.

18) Operation Alarm

Before performing any operation to the crane, press the horn to give alarms, indicating that the crane will be operated and reminding others of safety.

19) Traveling or Swing Hoist

During when traveling or swing, the alarming light flashes and swing buzzer tweets sounds.

20) Function Lock

- If the function locking handle is not at the proper position, all other function control handle will fail. It is used to prevent mis-use due to body impact when getting on or off the vehicle.
- If the operator is not on the seat, all devices will not work, to effectively avoid operational errors.

21) Automatic Reversing Traveling

Regardless of the relative positions of superstructure and undercarriage, if the traveling pedal is pushed forwards, the crane will travel forwards; if pulled backwards, it will travel backwards correspondingly.

22) Electronic Monitor

It can display the water temperature, fuel quantity, accumulated and present operating duration, oil pressure, engine speed, charging status of battery, and voltage. It is also equipped with main winch over roll-out alarm, auxiliary winch over roll-out alarm, and boom limit alarm; upon an alarm situation, the alarming light will turn on and the buzzer tweet.

23) Engine Power Limit Load Adjustment and Stalling Protection

It can monitor the engine output power in real time, to prevent the engine stopping and stall through the power load adjustment.

24) Monitoring Display

A high-precision display is used as the indication terminal for electric human-machine dialogues of the whole machine, to indicate the operating parameters of engine system and hydraulic system, parameter state of every detection point and output point of the electric system, and the real-time parameters of operating conditions under all circumstances.

25) Emergency Stop Function

In case of emergency, the operator can immediately shut down the entire machine by pressing the emergency stop button.

26) Lightning Protection Device (Optional)

The lightning protection device combines a base device and power surge device to effectively prevent damage to the electrical system, components and operator in case of lightning strike.

27) Remote Monitoring System (optional)

It can achieve the functions of GPS satellite positioning, GPRS data transmission, query and collection of equipment service states, and remote fault diagnosis, etc.

28) Illumination Lighting

The winch lighting lamp, short-beam lamp at the front of cab, front angle adjustable far-beam lamp, lamp in cab and the lighting device at night are equipped to improve visibility of construction.

29) Rearview Mirror

Set on the right of the driver's cab and armrest in front of hood for the convenience of monitoring the rear status of the machine.

MAIN PARAMETERS

Counterweight Parameters

Name	Q' ty	Length (m)	Width (m)	Height (m)	Weight of single piece (t)
Counterweight block	10	1.97	1.90	0.69	5.5
Counterweight tray	1	6.14	1.90	0.62	9
Central counterweight	2	3.95	1.44	0.73	10

Hook Parameters

Hook block Name	Max. hoisting capacity	Q' ty	Number of pulleys	Lines	Weight of single piece (t)
200t lifting hook	200t	1	9	16	3.83
150t lifting hook	150t	1	7	12	2.80
100t lifting hook	100t	1	5	8	1.99
50t ball hook	50t	1	3	4	1.06
25t lifting hook	25t	1	1	2	0.79
13.5t lifting hook	13.5t	1	0	1	0.53

SCC1800

24	Operating Condition Combination
26	H _L Operating Condition of Light-duty Boom
31	H Operating Condition of Heavy-duty Boom
35	LJ Operating Condition of Luffing Jib
41	FJ Operating Condition of Fixed Jib



OPERATING CONDITION COMBINATION

OPERATING CONDITION COMBINATION

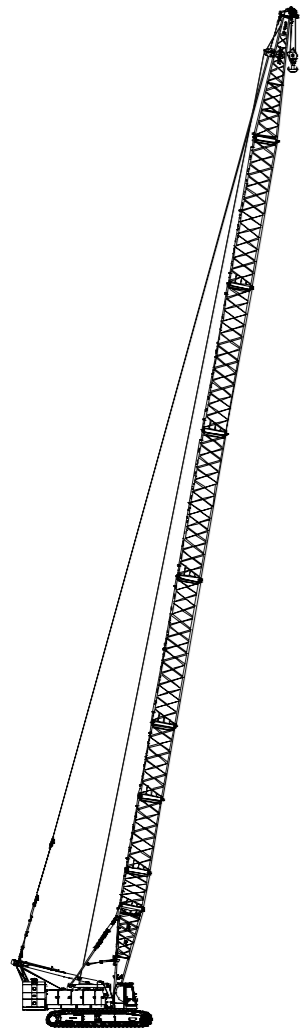

Light-duty Boom H_L
operating conditions
(16~85)m
(64+20)t

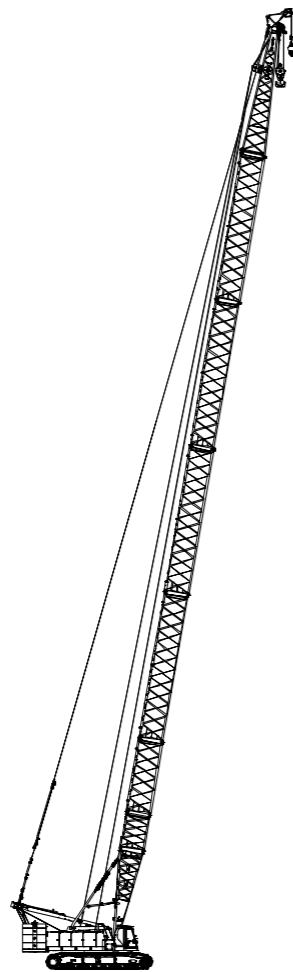

Light-duty boom extension
H_LC operating conditions
(16~85)m
(64+20)t

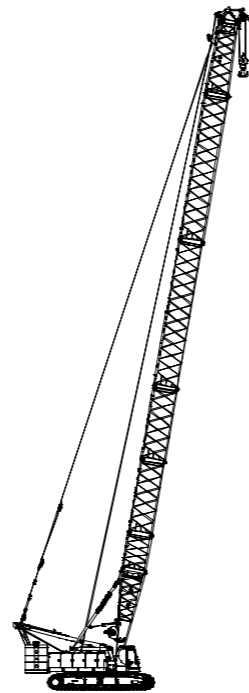

Heavy-duty boom H
operating conditions
(23~71)m
(64+20)t

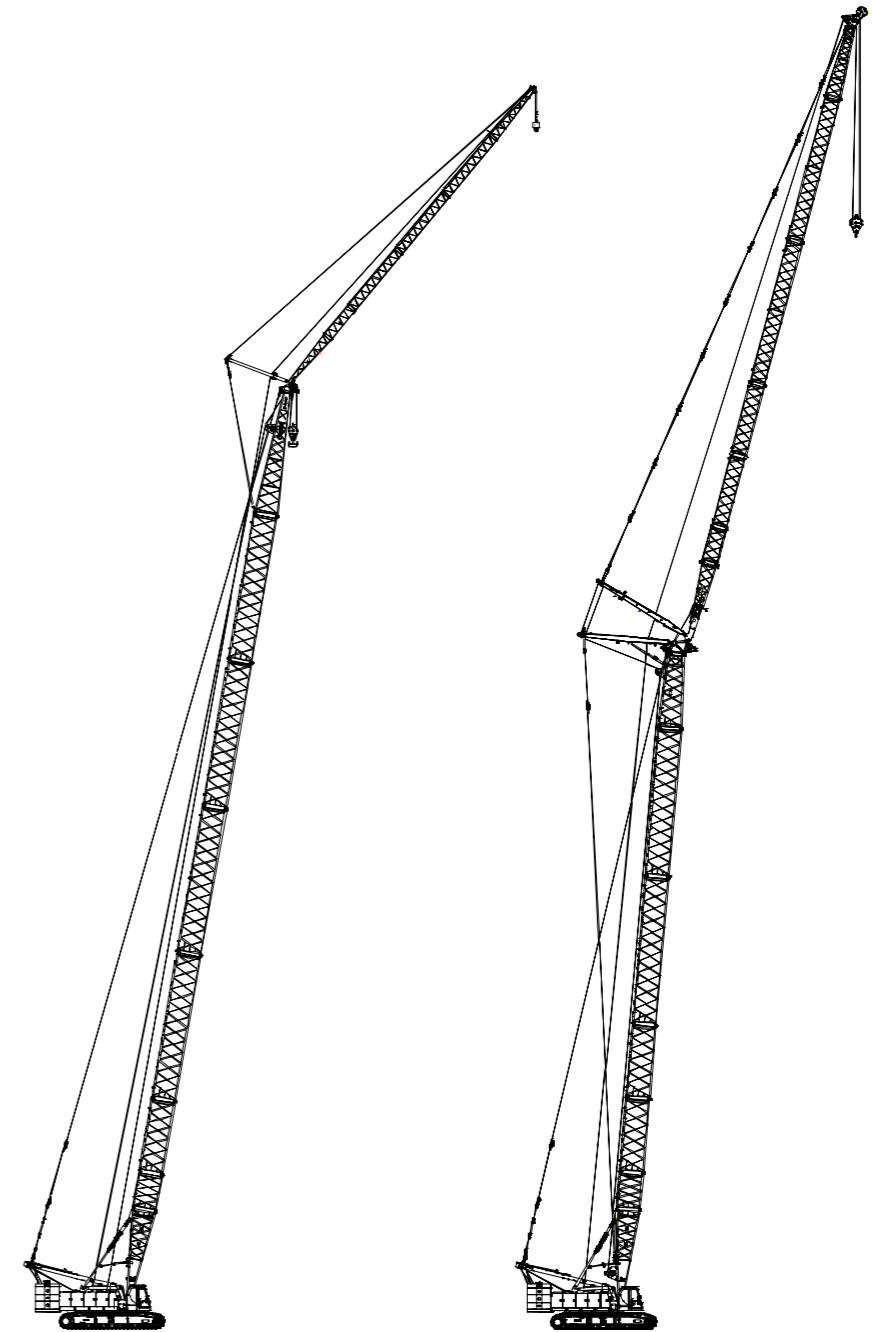

Fixed jib FJ operating
conditions
(70+31)m
(64+20)t

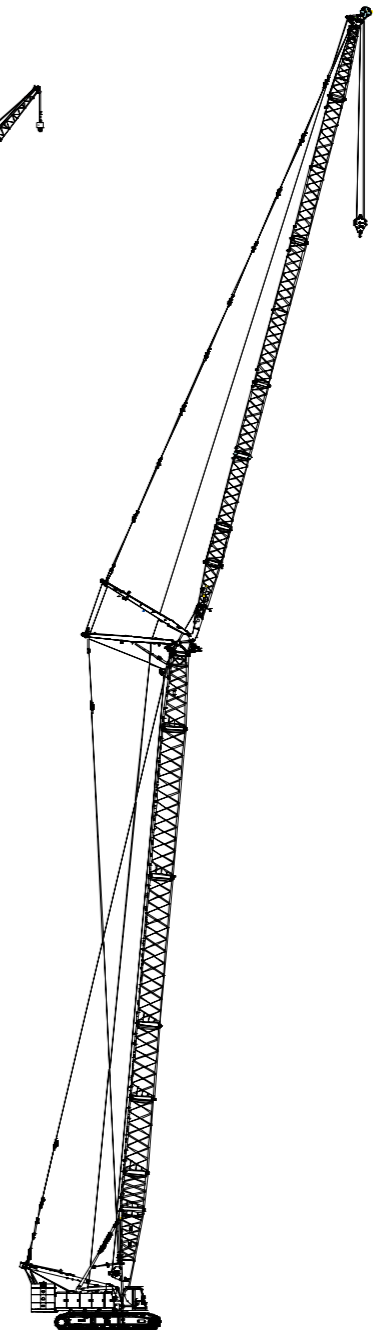

Luffing jib LJ operating
condition
(53+52)m
(64+50)t

H_L LIGHT-DUTY OPERATING CONDITIONS

Boom length m	Insert		
	3 m	6 m	12m
16	-	-	-
19	1	-	-
22	-	1	-
25	1	1	-
28	-	2	-
31	1	2	-
34	-	1	1
37	1	1	1
40	-	2	1
43	1	2	1
46	-	1	2
49	1	1	2
52	-	2	2
55	1	2	2
58	-	1	3
61	1	1	3
64	-	2	3
67	1	2	3
70	-	1	4
73	1	1	4
76	-	2	4
79	1	2	4
82	-	3	4
85	1	3	4

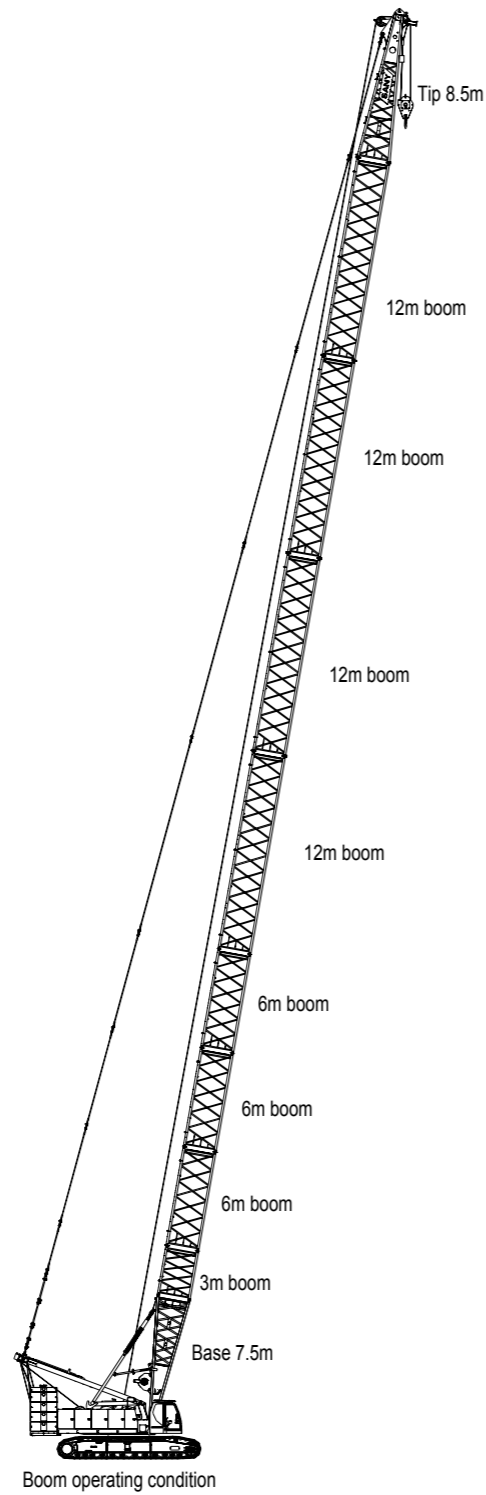

H_L LIGHT-DUTY RANGE DIAGRAM

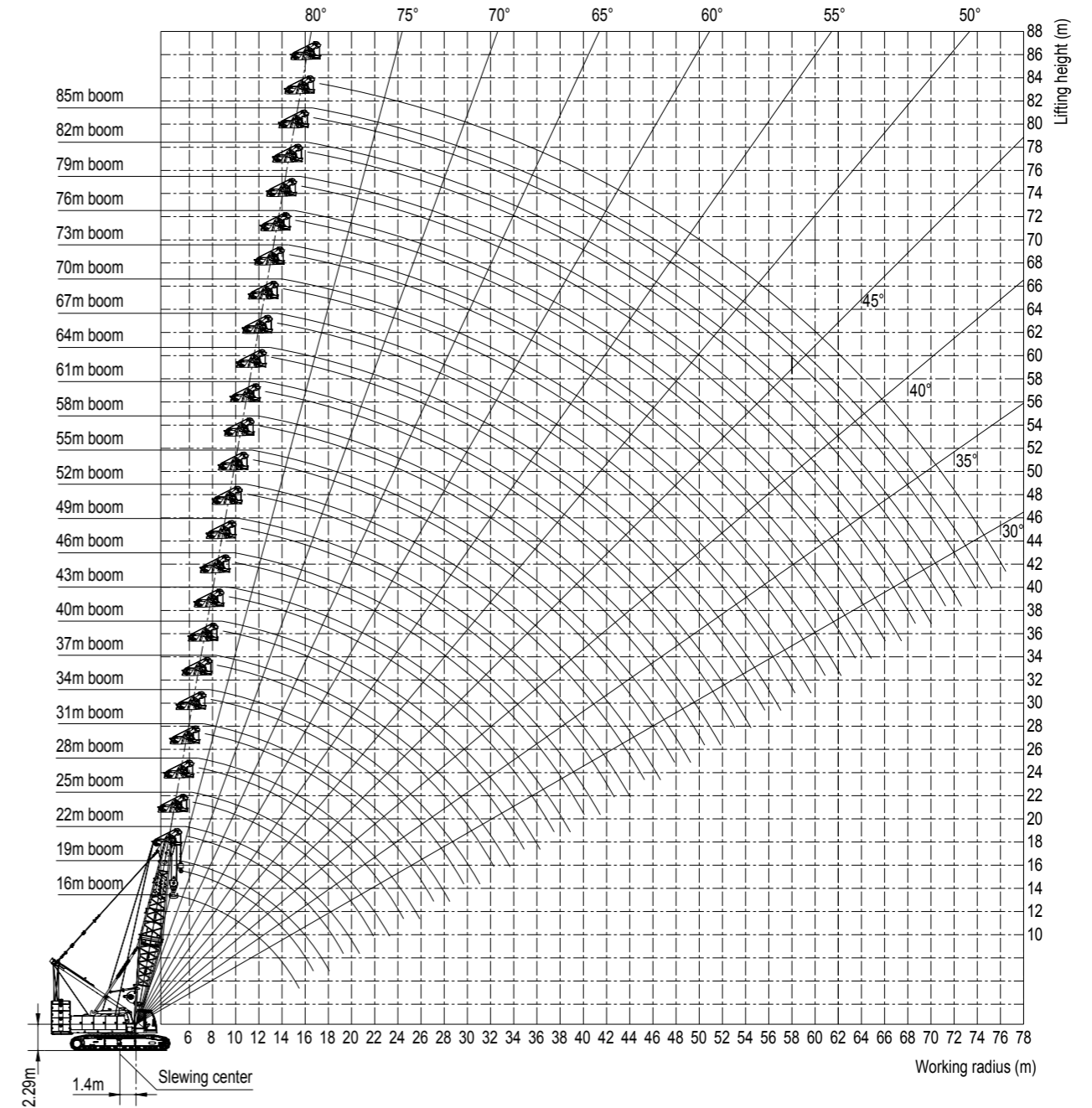

H_L LIGHT-DUTY RANGE DIAGRAM

Notes:

1. The rated load indicated in the table is the max. permissible value for objects hoisted slowly and stably on a level and hard ground when the crane does not travel.
2. The rated load indicated in the table is the value computed by taking 75% of the tipover load when the wind speed is below 9.8m/s.
3. All values in the load chart are suitable for 360° swing.
4. The boom that can be assembled is 16~85m long.

The value of load indicated is in the unit of t. The actual lifting capacity is the value obtained by deducting the weight of hoisting tools (e.g. main and auxiliary hook blocks) from the rated lifting capacity indicated in the table.

The weight of hook block is shown as below:

- 200t hook block – 3.83t
- 150t hook block – 2.80t
- 100t hook block – 1.99t
- 50t hook block – 1.06t
- 25t hook block – 0.79t
- 13.5t hook block – 0.53t

H_L LIGHT-DUTY RANGE DIAGRAM

SCC 1800 Crawler Crane Light-Duty Load Charts 1/2

Unit: (t)

Radius(m)	Arm length/m												
	16	19	22	25	28	31	34	37	40	43	46	49	
5	180.0/4.6	161.6/5.1	--	--	--	--	--	--	--	--	--	--	--
6	161.0	151.0	141.1/5.7	133.5/6.2	--	--	--	--	--	--	--	--	--
7	145.9	138.9	135.5	132.0	130/6.7	120/7.2	--	--	--	--	--	--	--
8	132.0	132.0	130.0	129.0	125.0	120.0	109.7/7.8	97.9/8.4	--	--	--	--	--
9	114.0	114.0	114.0	111.0	108.0	105.0	102.0	97.9	96.5/8.8	86.5/9.3	--	--	--
10	97.4	97.4	97.4	97.4	95.3	92.7	90.4	88.0	85.7	83.5	74.9/9.8	73.2/10.4	--
11	84.5	84.5	84.5	84.5	84.5	82.7	80.9	78.9	77.0	75.1	73.5	71.7	--
12	74.5	74.5	74.5	74.5	74.5	74.5	73.1	71.4	69.8	68.2	66.8	65.3	--
13	66.5	66.5	66.5	66.5	66.5	66.5	66.5	66.5	65.2	63.7	62.3	61.1	59.8
14	59.9	59.9	59.9	59.9	59.9	59.9	59.9	59.9	59.8	58.6	57.3	56.3	55.1
15	51.9	51.9	51.9	51.9	51.9	51.9	51.9	51.9	51.9	54.1	53.0	52.1	51.0
16	50.5/15.5	50.0	50.0	50.0	50.0	50.0	50.0	50.0	50.0	49.9	49.2	48.4	47.4
17	--	46.0	46.0	46.0	46.0	46.0	46.0	46.0	46.0	46.0	45.8	45.2	44.3
18	--	41.4	41.4	41.4	41.4	41.4	41.4	41.4	41.4	42.5	42.3	42.3	41.4
19	--	--	39.7	39.7	39.7	39.7	39.7	39.7	39.6	39.5	39.3	39.3	38.9
20	--	--	37.1/20.7	37.1	37.1	37.0	37.0	37.0	37.0	36.8	36.7	36.6	36.5
22	--	--	--	32.6	32.6	32.5	32.5	32.5	32.5	32.3	32.2	32.1	32.0
24	--	--	--	30/23.3	29.0	28.9	28.9	28.8	28.7	28.5	28.5	28.5	28.3
26	--	--	--	--	25.5/25.9	25.8	25.8	25.8	25.7	25.5	25.5	25.5	25.3
28	--	--	--	--	--	23.3	23.3	23.3	23.2	23.0	23.0	23.0	22.8
30	--	--	--	--	--	22.6/28.5	21.3	21.1	21.0	20.8	20.8	20.8	20.6
32	--	--	--	--	--	--	20.1/31.1	19.2	19.1	19.0	18.9	18.9	18.8
34	--	--	--	--	--	--	--	17.1/33.7	17.5	17.3	17.3	17.3	17.1
36	--	--	--	--	--	--	--	--	16.0	15.9	15.9	15.9	15.7
38	--	--	--	--	--	--	--	--	15.5/36.3	14.6	14.6	14.6	14.4
40	--	--	--	--	--	--	--	--	--	13.5/38.9	13.5	13.5	13.3
42	--	--	--	--	--	--	--	--	--	--	12.3/41.5	12.3	12.3
44	--	--	--	--	--	--	--	--	--	--	--	--	11.3
46	--	--	--	--	--	--	--	--	--	--	--	--	--
48	--	--	--	--	--	--	--	--	--	--	--	--	--
50	--	--	--	--	--	--	--	--	--	--	--	--	--
Counterweight (t)	64+20	64+20	64+20	64+20	64+20	64+20	64+20	64+20	64+20	64+20	64+20	64+20	64+20
Lines	16	14	12	11	11	10	9	8	8	7	6	6	6

- Notes: 1. The actual lifting capacities shown in the table are the values remained after the rated lifting capacities minus all lifting tools (like lifting hook).
 2. The rated lifting capacity indicated in the table is the weight hoisted slowly and stably on a level and hard soil ground when the crane does not travel.
 3. The orange-filled parts in the tables depend on structural strength.

H_L LIGHT-DUTY BOOM RANGE DIAGRAM

SCC 1800 Crawler Crane Light-Duty Load Charts 2/2

Unit:(t)

Radius(m)	Arm length/m												
	52	55	58	61	64	67	70	73	76	79	82	85	
11	63/10.9	62.6/11.4	--	--	--	--	--	--	--	--	--	--	--
12	63	62.4	61	50.9/12.4	--	--	--	--	--	--	--	--	--
13	58.5	57.2	56.1	50.9	50.3	46.1/13.5	--	--	--	--	--	--	--
14	53.9	52.8	51.8	50.7	49	45	41.7	38/14.5	--	--	--	--	--
15	50.0	48.9	48.1	47.1	46.1	43.9	40.6	37.6	34.6	31.6/15.5	--	--	--
16	46.5	45.5	44.7	43.8	43.0	42.1	39.6	36.6	33.9	31.4	29.1/16.1	26.5/16.6	--
17	43.4	42.5	41.8	41.0	40.1	39.3	38.6	35.7	33.1	30.6	28.4	26.3	--
18	40.7	39.8	39.2	38.4	37.6	36.9	36.2	34.7	32.2	29.7	27.6	25.5	--
19	38.2	37.4	36.8	36.1	35.4	34.6	34.0	33.3	31.3	28.9	26.8	24.8	--
20	36.0	35.2	34.7	34.0	33.3	32.6	32.1	31.4	30.4	28.1	26.1	24.1	--
22	31.8	31.5	31.0	30.3	29.7	29.1	28.6	28.0	27.4	26.6	24.7	22.8	--
24	28.2	28.0	27.9	27.3	26.7	26.1	25.7	25.1	24.6	24.1	23.4	21.6	--
26	25.1	24.9	24.9	24.7	24.2	23.6	23.2	22.7	22.2	21.7	21.2	20.4	--
28	22.6	22.4	22.3	22.1	21.9	21.4	21.1	20.6	20.1	19.6	19.1	18.6	--
30	20.4	20.2	20.2	20.0	19.8	19.5	19.2	18.7	18.3	17.8	17.3	16.9	--
32	18.6	18.4	18.3	18.1	17.9	17.7	17.5	17.1	16.6	16.2	15.8	15.3	--
34	17.0	16.7	16.7	16.5	16.3	16.1	15.9	15.6	15.2	14.8	14.3	13.9	--
36	15.5	15.3	15.2	15.0	14.8	14.6	14.5	14.3	13.9	13.5	13.1	12.7	--
38	14.3	14.0	14.0	13.8	13.6	13.3	13.2	13.0	12.7	12.3	11.9	11.5	--
40	13.1	12.9	12.8	12.6	12.4	12.2	12.1	11.9	11.7	11.3	10.9	10.5	--
42	12.1	11.9	11.8	11.6	11.4	11.2	11.1	10.9	10.7	10.3	10.0	9.6	--
44	11.2	11.0	10.9	10.7	10.5	10.3	10.2	9.9	9.7	9.5	9.1	8.7	--
46	10.3	10.1	10.1	9.8	9.7	9.4	9.3	9.1	8.9	8.7	8.3	7.9	--
48	9.8/47.1	9.3	9.3	9.1	8.9	8.7	8.6	8.3	8.1	7.9	7.6	7.2	--
50	--	8.5/49.7	8.6	8.4	8.2	8.0	7.9	7.6	7.4	7.2	6.9	6.5	--
52	--	--	7.6/51.9	7.7	7.5	7.3	7.2	7.0	6.8	6.6	6.3	5.9	--
54	--	--	--	7.1	6.9	6.7	6.6	6.4	6.2	6.0	5.7	5.3	--
56	--	--	--	6.8/54.5	6.4	6.2	6.1	5.9	5.6	5.4	5.2	4.8	--
58	--	--	--	--	6.0/57.5	5.7	5.6	5.3	5.1	4.9	4.7	4.3	--
60	--	--	--	--	--	5.2/69.7	5.1	4.9	4.7	4.4	4.2	3.8	--
62	--	--	--	--	--	--	4.6	4.4	4.2	4.0	3.8	3.4	--
64	--	--	--	--	--	--	4.3/62.3	4.0	3.8	3.6	3.3	3.0	--
66	--	--	--	--	--	--	--	3.5/65	3.4	3.2	2.9	2.6	--
68	--	--	--	--	--	--	--	--	2.8/67.5	2.8	2.6	2.2	--
70	--	--	--	--	--	--	--	--	--	2.5	2.2	1.9	--
72	--	--	--	--	--	--	--	--	--	--	1.9	1.5	--
74	--	--	--	--	--	--	--	--	--	--	--	1.2	--
Counterweight (t)	64+20	64+20	64+20	64+20	64+20	64+20	64+20	64+20	64+20	64+20	64+20	64+20	64+20
Lines	5	5	5	4	4	4	4	3	3	3	3	2	

Notes:1.The actual lifting capacities shown in the table are the values remained after the rated lifting capacities minus all lifting tools (like lifting hook).
2.The rated lifting capacity indicated in the table is the weight hoisted slowly and stably on a level and hard soil ground when the crane does not travel.
3.The orange-filled parts in the tables depend on structural strength.

H OPERATING CONDITION OF HEAVY-DUTY BOOM

Boom length m	Insert		
	3 m	6 m	12m
23	1	1	--
26	--	2	--
29	1	2	--
32	--	1	1
35	1	1	1
38	--	2	1
41	1	2	1
44	--	1	2
47	1	1	2
50	--	2	2
53	1	2	2
56	--	1	3
59	1	1	3
62	--	2	3
65	1	2	3
68	--	3	3
71	1	3	3

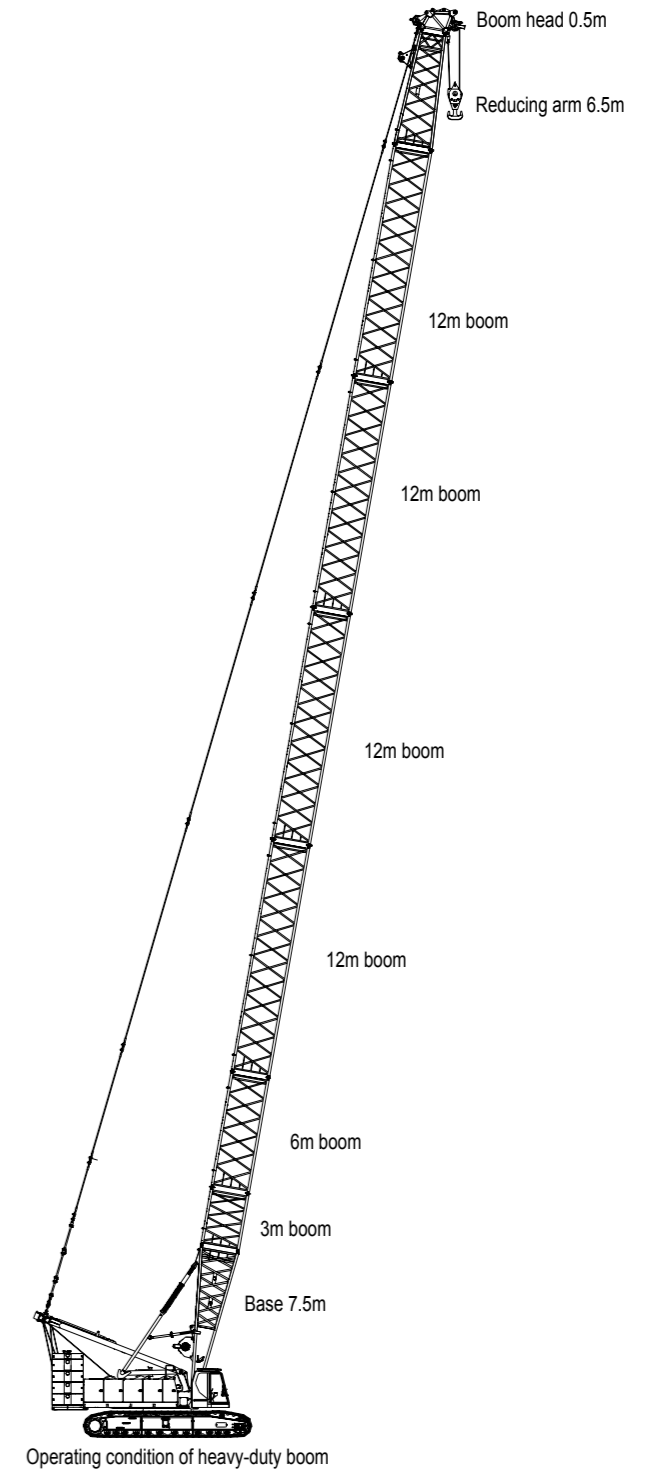

Operating condition of heavy-duty boom

HEAVY-DUTY RANGE DIAGRAM

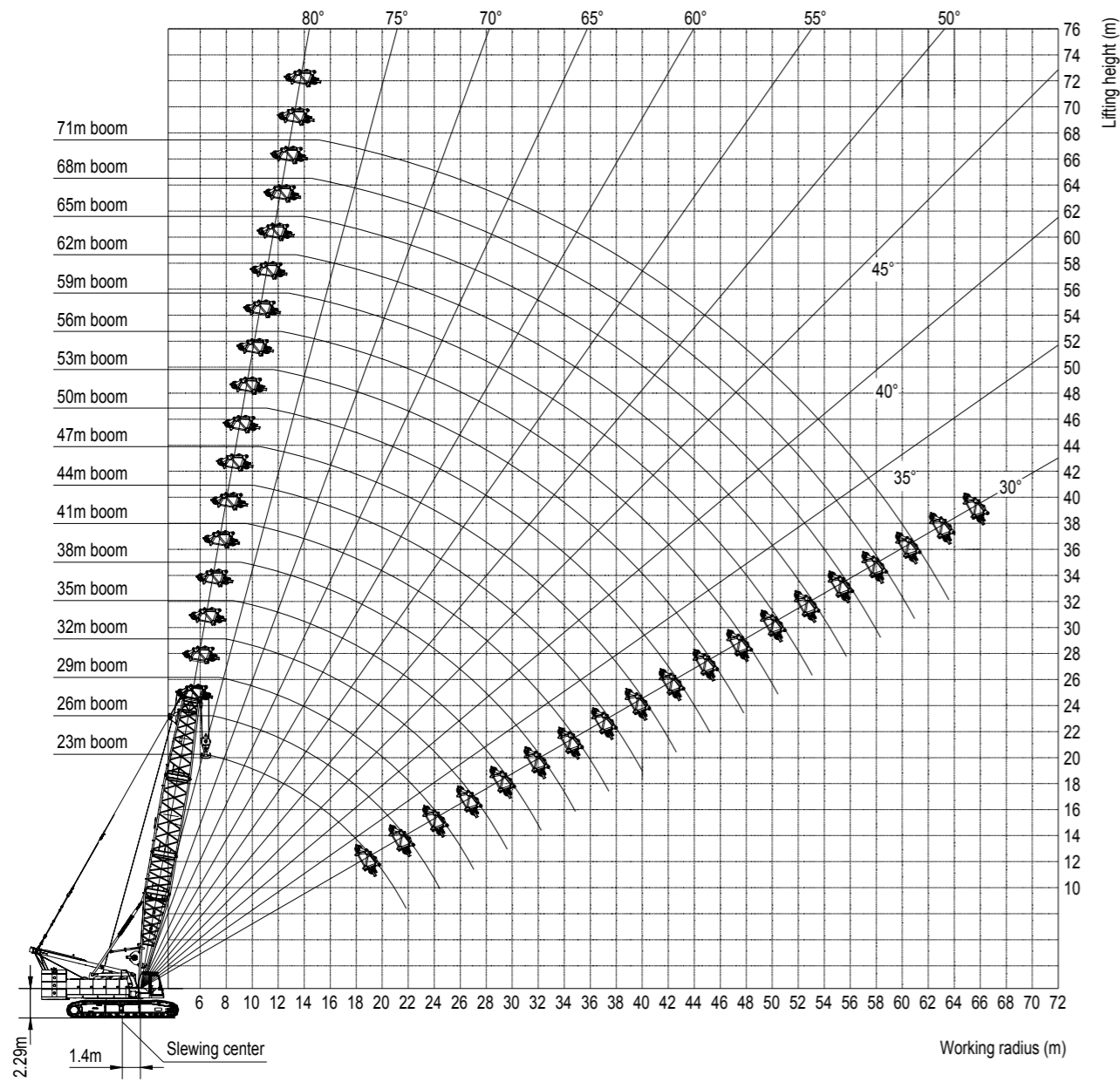

HEAVY-DUTY LOAD CHARTS

SCC1800 Crawler Crane – Heavy-Duty Load Charts 1/2

Boom length 23-71m Rear counterweight 66t Central counterweight 20t

Unit: (t)

Radius(m)	Boom length(m)									
	23	26	29	32	35	38	41	44	47	50
6	100/6.43									
7	100	100/6.95		100/7.47						
8	100	100	100	100	100/8.51					
9	100	100	100	100	100	97.6/9.04		86.5/9.56		
10	97.4	96.8	94.1	91.8	89.3	87	84.7	82/10.08		74.9/10.6
11	84.5	84.6	83.9	82	80	78	76.1	74.4	72.6	68.6/11.12
12	74.5	74.5	74.4	74	72.3	70.6	69	67.6	66	64.5
13	66.4	66.5	66.4	66.5	65.9	64.4	63	61.8	60.4	59.1
14	59.9	59.9	59.8	60	59.8	59.2	57.9	56.8	55.6	54.5
15	54.4	54.4	54.3	54.5	54.4	54.3	53.5	52.5	51.5	50.4
16	49.8	49.8	49.7	49.9	49.7	49.6	49.4	48.8	47.8	46.9
17	45.8	45.8	45.7	45.9	45.7	45.6	45.5	45.5	44.6	43.7
18	42.3	42.4	42.3	42.4	42.3	42.2	42	42	41.7	40.9
19	39.3	39.4	39.3	39.4	39.3	39.2	39	39	38.8	38.4
20	36.6	36.7	36.6	36.8	36.6	36.5	36.3	36.3	36.1	36
21	34.2	34.3	34.2	34.4	34.3	34.1	34	34	33.8	33.6
22		32.2	32.1	32.3	32.1	32	31.8	31.8	31.6	31.5
23		30.3	30.2	30.4	30.2	30.1	29.9	29.9	29.7	29.6
24		28.5	28.5	28.6	28.5	28.4	28.2	28.2	28	27.8
25			26.9	27.1	26.9	26.8	26.6	26.6	26.4	26.3
26			25.4	25.6	25.5	25.4	25.2	25.2	25	24.8
27				24.3	24.2	24	23.9	23.9	23.7	23.5
28				23.1	22.9	22.8	22.6	22.7	22.5	22.3
29				21.9	21.8	21.7	21.5	21.5	21.3	21.2
30					20.8	20.7	20.5	20.5	20.3	20.1
31					19.8	19.7	19.5	19.5	19.3	19.2
32						18.8	18.6	18.6	18.4	18.3
33						17.9	17.8	17.8	17.6	17.4
34						17.1	17	17	16.8	16.6
35							16.2	16.3	16.1	15.9
36							15.5	15.6	15.4	15.2
37							14.9	14.9	14.7	14.5
38								14.3	14.1	13.9
39									13.7	13.3
40									12.9	12.8
41									12.4	12.3
42									11.9	11.8
43										11.3
44										10.8
Counterweight (t)	64+20	64+20	64+20	64+20	64+20	64+20	64+20	64+20	64+20	64+20
Lines	8	8	8	8	8	8	7	7	6	6

Notes: 1. The actual lifting capacity must be obtained by deducting the weights of lifting hook, hoisting tools, and wire rope wound around the lifting hook and arm head from the rated lifting capacity in the table.
 2. The rated lifting capacity indicated in the table is the weight hoisted slowly and stably on a level and hard soil ground when the crane does not travel.

HEAVY-DUTY LOAD CHARTS

SCC1800 Crawler Crane – Heavy-Duty Load Charts 2/2

Boom length 23-71m Rear counterweight 64t Central counterweight 20t

Unit: (t)

Radius(m)	Boom length(m)						
	53	56	59	62	65	68	71
11	61.5/11.64						
12	60.9	55.2/12.17	49.9/12.69				
13	57.8	54	49.5	44.8/13.21			
14	53.3	52.3	48.2	43.9	40.5/13.73	36.8/14.25	
15	49.4	48.5	47	42.7	39.2	36.1	33.1/14.77
16	45.9	45.1	44.2	41.7	38.2	35.1	32
17	42.8	42.1	41.3	40.5	37.2	34.2	31.2
18	40.1	39.5	38.7	37.9	36.1	33.3	30.2
19	37.7	37.1	36.3	35.6	34.9	32.3	29.4
20	35.5	34.9	34.2	33.5	32.8	31.4	28.5
21	33.4	32.9	32.3	31.6	31	30.5	27.7
22	31.3	31.1	30.5	29.9	29.3	28.8	26.9
23	29.4	29.3	28.9	28.3	27.7	27.2	26.2
24	27.6	27.6	27.3	26.9	26.3	25.8	25.3
25	26	26	25.8	25.5	25	24.5	24
26	24.6	24.5	24.3	24.1	23.7	23.3	22.8
27	23.3	23.2	23	22.8	22.6	22.2	21.7
28	22.1	22	21.8	21.6	21.4	21.1	20.7
29	20.9	20.9	20.7	20.5	20.2	20.1	19.7
30	19.9	19.8	19.6	19.4	19.2	19.1	18.8
31	18.9	18.9	18.7	18.5	18.2	18.1	17.9
32	18	18	17.8	17.6	17.3	17.2	17
33	17.2	17.1	16.9	16.7	16.5	16.4	16.2
34	16.4	16.3	16.1	15.9	15.7	15.6	15.4
35	15.7	15.6	15.4	15.2	15	14.9	14.6
36	15	14.9	14.7	14.5	14.3	14.2	13.9
37	14.3	14.3	14	13.8	13.6	13.5	13.3
38	13.7	13.6	13.4	13.2	13	12.9	12.7
39	13.1	13.1	12.8	12.6	12.4	12.3	12.1
40	12.6	12.5	12.3	12.1	11.9	11.8	11.5
41	12	12	11.8	11.6	11.3	11.2	11
42	11.6	11.5	11.3	11.1	10.8	10.7	10.5
43	11.1	11	10.8	10.6	10.4	10.3	10
44	10.6	10.6	10.4	10.2	9.9	9.8	9.6
45	10.2	10.1	9.9	9.7	9.5	9.4	9.2
46	9.8	9.7	9.5	9.3	9.1	9	8.8
47	9.4	9.3	9.1	8.9	8.7	8.6	8.4
48		9	8.7	8.6	8.3	8.2	8
49		8.6	8.4	8.2	8	7.9	7.6
50		8.2	8	7.8	7.6	7.5	7.3
51			7.7	7.5	7.3	7.2	7
52			7.4	7.2	7	6.9	6.6
53				6.9	6.7	6.6	6.3
54				6.6	6.4	6.3	6
55				6.3	6.1	6	5.8
56					5.8	5.7	5.5
57					5.6	5.5	5.2
58						5.2	5
59						5	4.7
60						4.7	4.5
61							4.3
62							4.1
63							3.8
Counterweight (t)	64+20	64+20	64+20	64+20	64+20	64+20	64+20
Lines	5	5	4	4	4	3	3

Notes:1.The actual lifting capacity must be obtained by deducting the weights of lifting hook, hoisting tools, and wire rope wound around the lifting hook and arm head from the rated lifting capacity in the table.
2.The rated lifting capacity indicated in the table is the weight hoisted slowly and stably on a level and hard soil ground when the crane does not travel.

LUFFING JIB OPERATION CONDITION

Jib length (m)	Insert			Boom length (m)	Boom angle
	3 m	6 m	12m		
22	1	1	-	23~53	65° ~85°
25	-	2	-	23~53	65° ~85°
31	-	1	1	23~53	65° ~85°
37	-	2	1	23~53	65° ~85°
43	-	1	2	23~53	65° ~85°
52	1	2	2	23~53	65° ~85°

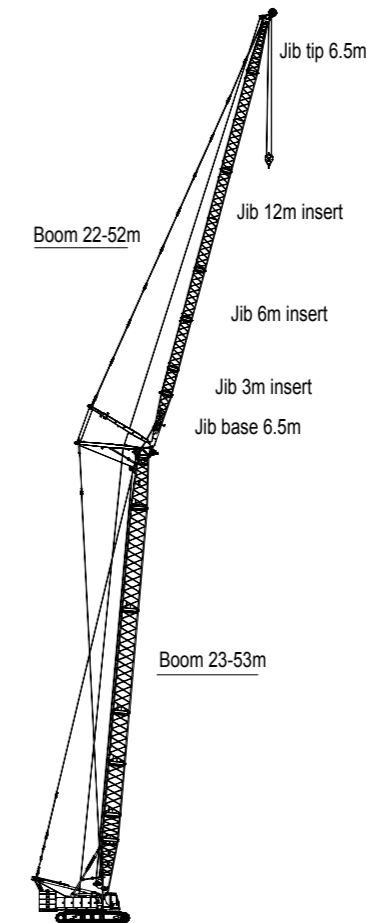

LUFFING JIB RANGE DIAGRAM

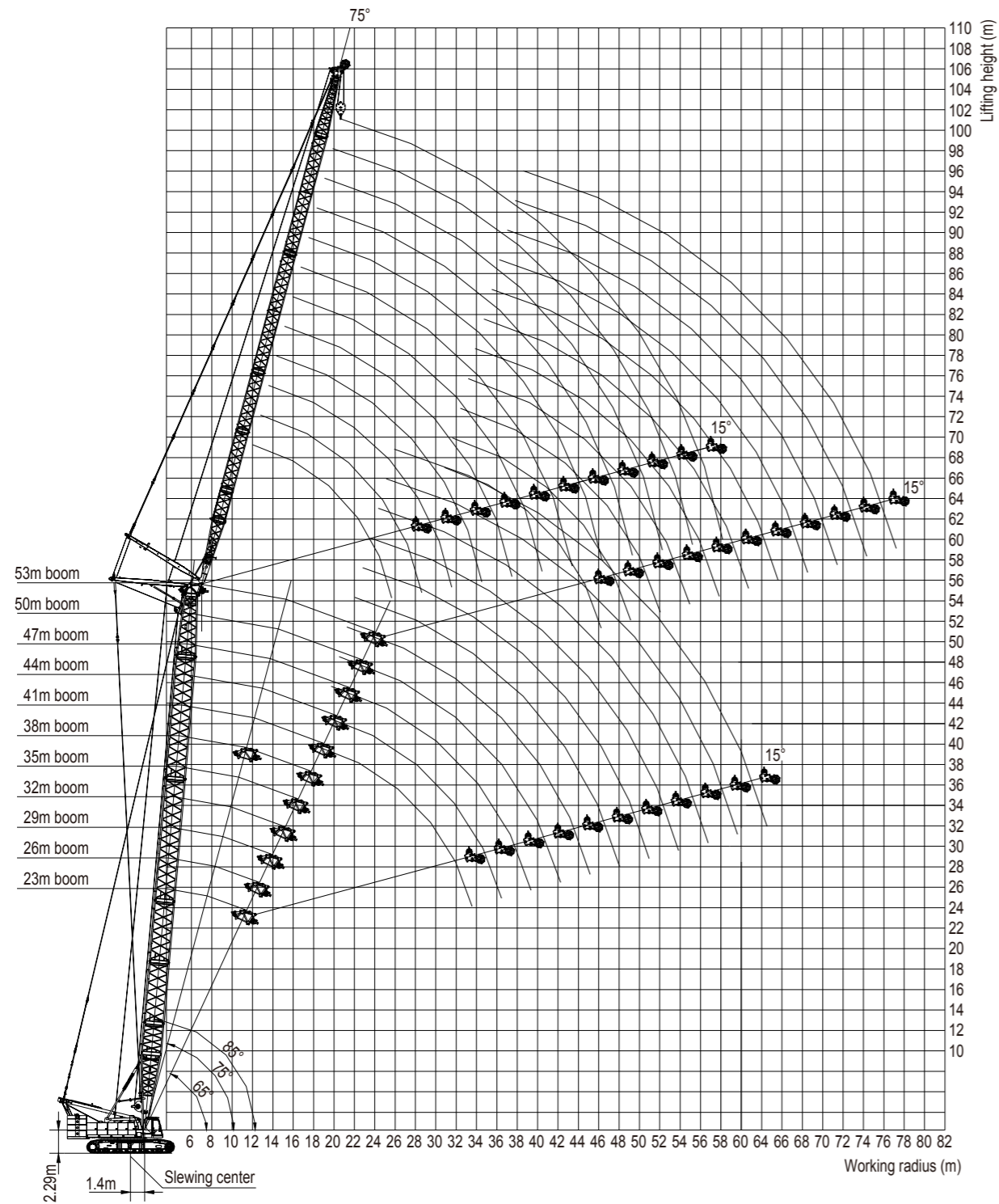

LUFFING JIB LOAD CHARTS

Notes:

1. The rated load indicated in the table is the max. permissible value for objects hoisted slowly and stably on a level and hard ground when the crane does not travel.
2. The rated load indicated in the table is the value computed by taking 75% of the tipover load when the wind speed is below 9.8m/s. The value of load indicated is in the unit of t. The actual lifting capacity is the value obtained by deducting the weight of hoisting tools (e.g. main and auxiliary hook blocks) from the rated lifting capacity indicated in the table.
The weight of hook block is shown as below:
 - 100t hook block – 1.99t
 - 50t ball hook – 1.06t
 - 25t ball hook – 0.79t
 - 13.5t ball hook – 0.53t
3. All values in the load chart are suitable for 360° swing.

LUFFING JIB LOAD CHARTS

SCC 1800 Crawler Crane – Luffing Jib Load Charts

Boom 23m Boom angle 85° Jib length 22-52m Rear counterweight 64t Central counterweight 20t Unit: (t)

Radius(m)	Boom length(m)					
	22	25	31	37	43	52
10	61.3/10.3m	54.3/11.1m				
12	54.8	54.3	54.3/11.9m			
14	48.7	48.7	48.4	35.8/13.4m		
16	42.2	42.0	41.3	35.5	26.2	
18	35.6	35.4	34.7	32.9	24.5	15.6/17.3m
20	30.7	30.6	30.4	29.9	22.6	14.4
22	26.8	26.6	26.5	25.7	21.0	13.3
24	23.7	23.5	23.4	21.8	19.6	12.5
26		21.7	21.1	20.3	18.5	11.6
28		19.8	19.6	19.0	17.3	10.9
30			17.8	17.2	16.4	10.2
32			16.2	15.5	14.5	9.5
34				14.8	13.5	9.0
36				13.5	12.5	8.5
38					11.5	8.0
40					10.5	7.6
42					9.1	7.2
44						6.8
46						6.3
48						6.2
50						5.9
Lines	5	5	5	3	3	2

SCC 1800 Crawler Crane – Luffing Jib Load Charts

Boom 26m Boom angle 85° Jib length 22-52m Rear counterweight 64t Central counterweight 20t Unit: (t)

Radius(m)	Boom length(m)					
	22	25	31	37	43	52
10	54.8/10.6m					
12	54.8	54.3/11.4m	54.3/12.9m			
14	48.4	48.4	48.4	35.5/15m		
16	41.3	41.3	41.3	35.5	26.2	
18	34.7	35.4	35.4	32.9	24.5	15.5/18.3m
20	30.6	30.4	30.4	30.4	22.6	14.4
22	25.7	25.7	25.7	25.7	21.0	13.3
24	24.4	23.4	23.4	23.4	19.6	12.5
26		21.7	21.1	21.1	18.5	11.6
28		19.6	19.0	19.0	17.3	10.9
30			17.2	17.2	16.4	10.2
32			16.2	16.2	15.5	9.5
34			14.8	14.8	14.7	9.0
36				13.5	13.5	8.5
38				12.5	12.5	8.0
40				11.5	11.5	7.6
42					10.5	7.2
44					9.1	6.8
46					8.1	6.3
48						6.2
50						5.9
52						5.7
54						5.5
Lines	5	5	5	3	3	2

LUFFING JIB LOAD CHARTS

SCC 1800 Crawler Crane – Luffing Jib Load Charts

Boom 35m Boom angle 85° Jib length 22-52m Rear counterweight 64t Central counterweight 20t Unit: (t)

Radius(m)	Boom length(m)					
	22	25	31	37	43	52
12	54.9/11.4m	54.3/12.1m				
14	49.9	49.5	47.3/13.7m			
16	43.8	43.5	42.7	35.8/15.2m	26.2/16.8m	
18	36.7	36.4	35.8	33.3	24.7	15.6/19m
20	31.5	31.2	30.9	30.6	22.9	14.6
22	28.3	27.4	27.1	27.0	21.3	13.5
24	24.9	24.1	23.9	21.7	19.9	12.6
26	22.2	21.5	20.9	19.5	18.6	11.7
28		19.9	19.3	17.5	17.5	11.0
30			18.0	17.4	16.4	10.3
32			17.2	15.8	15.6	9.6
34			15.0	14.9	14.8	9.0
36				13.7	13.6	8.5
38				12.6	12.3	8.0
40				11.6	11.5	7.6
42					10.7	7.2
44					9.6	6.8
46					8.6	6.5
48						6.2
50						5.9
52						5.7
54						5.5
Lines	5	5	4	3	3	2

SCC 1800 Crawler Crane – Luffing Jib Load Charts

Boom 38m Boom angle 85° Jib length 22-52m Rear counterweight 64t Central counterweight 20t Unit: (t)

Radius(m)	Boom length(m)					
	22	25	31	37	43	52
12	55/11.6m	47.3/12.4m				
14	49.8	47.3	47.3	35.8/15.5m		
16	43.8	43.5	43.1	35.8		
18	36.9	36.7	36.1	33.4	24.8	
20	31.6	31.4	31.0	30.8	23.0	13.5/19.4m
22	28.5	27.5	27.2	26.7	21.3	13.5
24	25.0	24.2	24.0	22.0	19.9	12.6
26	22.3	21.6	20.7	18.6	17.6	11.8
28		20.0	19.4	17.5	17.5	11.0
30			18.0	17.4	16.5	10.3
32			16.4	15.6	15.6	9.6
34			15.0	14.8	14.6	9.0
36				13.8	13.7	8.5
38				12.6	12.5	8.0
40				11.6	11.0	7.6
42					10.7	7.2
44					9.7	6.8
46					8.7	6.5
48						6.2
50						5.9
52						5.7
54						5.5
Lines	5	4	4	3	2	2

LUFFING JIB LOAD CHARTS

SCC 1800 Crawler Crane – Luffing Jib Load Charts

Boom 50m Boom angle 85° Jib length 22-52m Rear counterweight 64t Central counterweight 20t Unit: (t)

Radius(m)	Boom length(m)					
	22	25	31	37	43	52
12	47.3/12.7m	35.8/13.4m				
14	47.3	35.8				
16	42.3	35.8	35.8	32.9/16.6m		
18	37.1	35.8	35.8	32.6	25.2/18.1m	
20	32.4	32.3	31.6	31.4	23.2	14.9/20.4m
22	28.7	28.1	27.8	27.2	21.6	13.7
24	25.5	24.7	24.4	23.3	20.1	12.7
26	22.7	21.9	21.6	20.1	18.8	11.8
28	20.3	19.6	19.1	17.7	17.5	11.0
30		18.4	17.6	16.8	16.6	10.3
32			16.6	15.9	15.7	9.7
34			15.2	14.8	14.4	9.1
36			13.9	13.8	12.8	8.6
38				12.7	12.6	8.1
40				8.8	11.7	7.6
42				6.1	10.8	7.2
44					10.0	6.9
46					9.0	6.5
48					8.1	6.2
50						5.9
52						5.7
54						5.4
56						5.1
Lines	4	3	3	3	2	2

SCC 1800 Crawler Crane – Luffing Jib Load Charts

Boom 52m Boom angle 85° Jib length 22-52m Rear counterweight 64t Central counterweight 20t Unit: (t)

Radius(m)	Boom length(m)					
	22	25	31	37	43	52
12	35.8/12.9m	35.8/13.7m				
14	35.8	35.8	35.8/15.3m			
16	35.8	35.8	35.8	31.7/16.8m		
18	35.8	35.8	35.4	31.3	23.7/18.4m	
20	32.1	32.4	32.1	30.8	23.3	14.9/20.7m
22	27.7	28.0	28.7	28.2	21.7	13.8
24	23.9	24.6	25.2	25.7	20.2	12.7
26	21.9	21.7	22.5	22.8	18.8	11.8
28	20.2	17.8	20.0	20.4	17.7	11.0
30		16.4	17.9	18.4	16.6	10.3
32			16.3	16.7	15.7	9.7
34			15.2	15.2	14.8	9.1
36			14.2	14.0	13.9	8.6
38				12.8	12.7	8.1
40				12.0	11.8	7.7
42				11.0	10.8	7.2
44					10.0	6.9
46					9.1	6.5
48					8.2	6.2
50						5.9
52						5.7
54						5.4
56						5.1
Lines	3	3	3	3	2	2

FJ OPERATING CONDITION

Jib length (m)	Insert		boom length (m)	Included angle between boom and jib
	3 m	6 m		
13	1	-	28—70	10°, 30°
19	1	1	28—70	10°, 30°
25	1	2	28—70	10°, 30°
31	1	3	28—70	10°, 30°

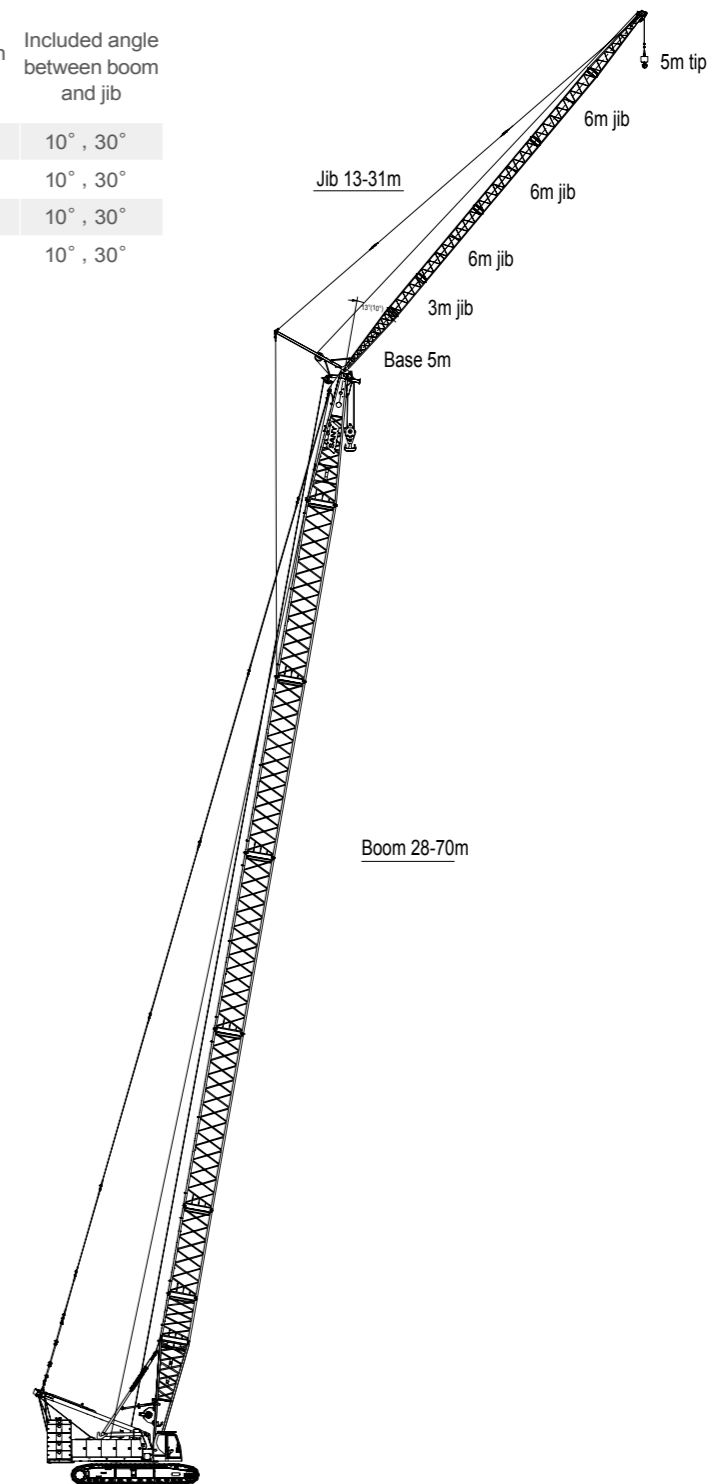

FIXED JIB RANGE DIAGRAM

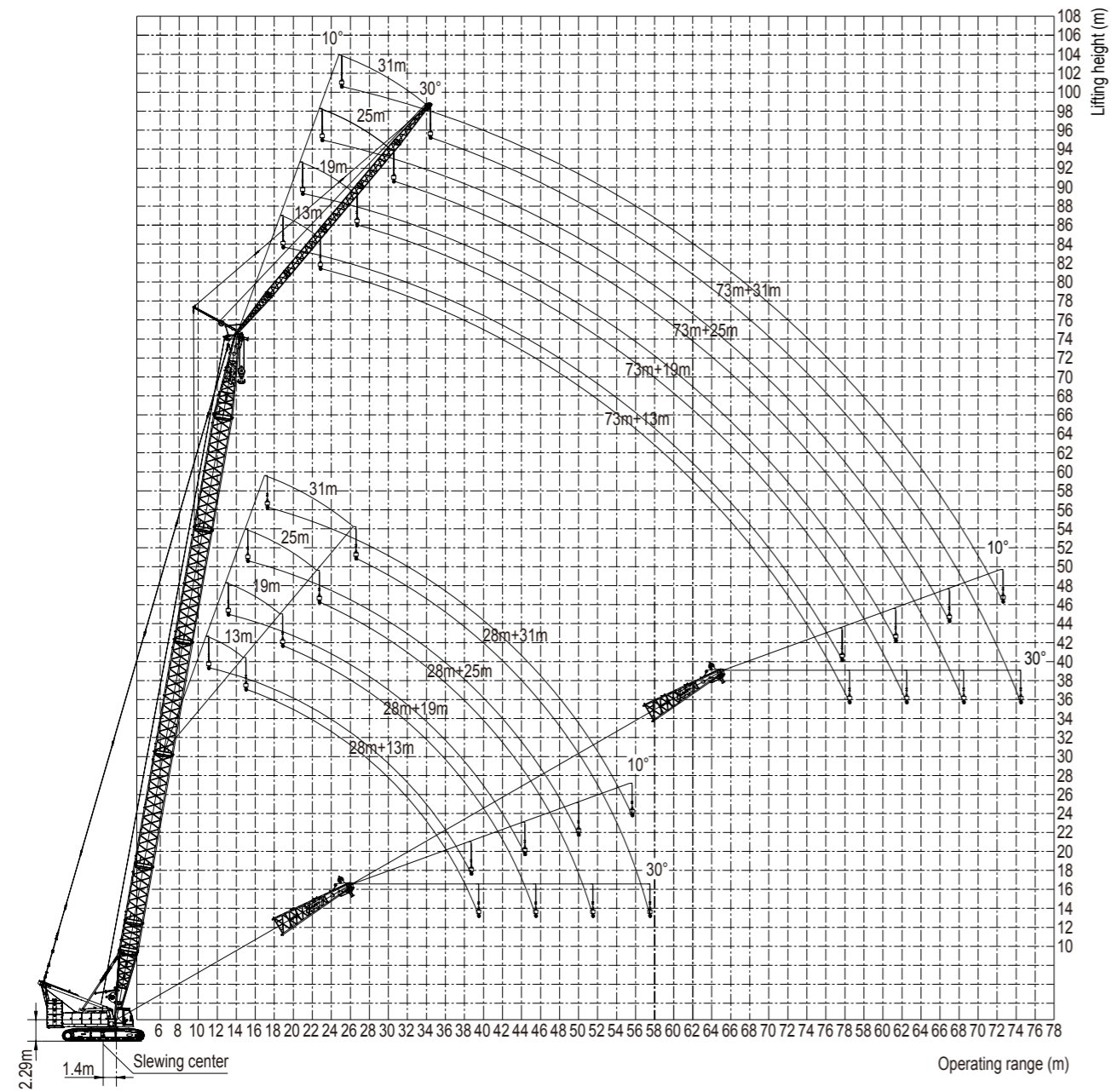

FIXED JIB LOAD CHART

Notes:

1. The rated load indicated in the table is the max. permissible value for objects hoisted slowly and stably on a level and hard ground when the crane does not travel.
2. The rated load indicated in the table is the value computed by taking 75% of the tipover load when the wind speed is below 9.8m/s. The value of load indicated is in the unit of t. The actual lifting capacity is the value obtained by deducting the weight of hoisting tools (e.g. main and auxiliary hook blocks) from the rated lifting capacity indicated in the table.
The weight of hook block is shown as below:
 - 25t ball hook – 0.79t
 - 13.5t ball hook – 0.53t
3. All values in the load chart are suitable for 360° swing.

FIXED JIB LOAD CHART

SCC 1800 Crawler Crane – Fixed Jib Load Charts

No main hook, jib deflection angle: 10°

Unit: (t)

Boom length Radius	28m				31m				34m			
	Jib length 13m	19m	25m	31m	13m	19m	25m	31m	13m	19m	25m	31m
10m	25/10.4				25/10.8				25/11.3			
12m	25.0	21.2/12.3			25.0	21.2/12.8			25.0	21.2/13.3		
14m	23.5	19.7	11.6/14.3		23.9	20.0	11.9/14.7		24.3	20.3	11.9/15.2	
16m	22.0	18.4	11.3	6.2/16.2	22.6	18.8	11.4	6.6/16.7	23.0	19.1	11.5	6.6/17.2
18m	20.5	17.3	10.5	6.1	21.4	17.7	10.7	6.2	21.8	18.0	10.9	6.3
20m	19.2	16.3	9.9	5.8	20.3	16.6	10.1	5.9	20.7	17.0	10.3	5.9
22m	18.1	15.4	9.4	5.4	19.2	15.8	9.6	5.5	19.7	16.1	9.8	5.6
24m	17.1	14.5	8.9	5.1	18.2	14.9	9.1	5.1	18.7	15.3	9.3	5.2
26m	16.1	13.7	8.4	4.7	17.4	14.2	8.6	4.9	17.8	14.5	8.8	5.0
28m	15.2	12.5	8.0	4.5	16.4	13.3	8.2	4.6	17.0	13.8	8.3	4.7
30m	14.4	11.6	7.5	4.2	15.5	12.2	7.7	4.3	16.2	12.8	8.0	4.4
32m	13.7	10.7	7.2	4.0	14.7	11.3	7.3	4.1	15.3	11.8	7.5	4.2
34m	13.0	10.0	6.8	3.8	13.8	10.5	7.0	3.9	14.5	11.1	7.1	3.9
36m	12.3	9.3	6.4	3.6	13.0	9.8	6.6	3.6	13.7	10.3	6.9	3.7
38m	11.8/37.1	8.7	6.2	3.3	12.2	9.2	6.3	3.4	12.9	9.7	6.5	3.5
40m		8.2	5.8	3.1	11.6/39.7	8.6	6.1	3.2	12.1	9.0	6.2	3.4
42m		7.7	5.6	3.0		8.1	5.7	3.1	11.5	8.5	5.9	3.2
44m		7.5/42.9	5.3	2.8		7.7	5.5	2.9	11.2/42.4	8.1	5.7	3.0
46m			5.2	2.7		7.4/45.5	5.3	2.7		7.6	5.4	2.8
48m			4.9	2.5			5.1	2.6		7.3	5.2	2.7
50m			4.8/48.9	2.4			4.9	2.5		7.1/48.1	5.0	2.6
52m				2.2			4.8/51.5	2.3			4.8	2.5
54m				2.1				2.2			4.7	2.3
56m					2.1/54.6			2.2			4.6/54.2	2.2
58m									2.1/57.2			2.1
60m												2.0/59.9
Counterweight (t)	64+20	64+20	64+20	64+20	64+20	64+20	64+20	64+20	64+20	64+20	64+20	64+20
Lines	2	2	1	1	2	2	1	1	2	2	1	1

FIXED JIB LOAD CHART

SCC 1800 Crawler Crane – Fixed Jib Load Charts

No main hook, jib deflection angle: 10°

Unit: (t)

Boom length Radius	46m				49m				52m			
	Jib length 13m	19m	25m	31m	13m	19m	25m	31m	13m	19m	25m	31m
12m	25/13.2				25/13.7							
14m	25.0	20.9/15.1			25.0	20.9/15.6			25/14.1			
16m	24.2	20.0	11.7/17.1		24.5	20.3	11.7/17.6		24.7	20.1/16.1		
18m	23.2	19.0	11.4	6.5/19.0	23.4	19.3	11.5	6.5/19.5	23.6	19.5	11.5/18.0	
20m	22.1	18.1	10.8	6.2	22.4	18.3	11.0	6.3	22.7	18.5	11.1	6.4/20.0
22m	21.1	17.2	10.4	5.9	21.3	17.4	10.4	6.0	21.5	17.7	10.5	6.0
24m	20.1	16.3	9.8	5.6	20.2	16.6	9.9	5.7	20.6	16.8	10.0	5.7
26m	19.1	15.6	9.3	5.3	19.2	15.8	9.5	5.3	19.7	16.1	9.6	5.4
28m	18.2	14.9	9.0	5.0	18.3	15.2	9.1	5.1	18.9	15.4	9.2	5.2
30m	17.3	14.3	8.6	4.8	17.6	14.5	8.7	4.8	18.1	14.7	8.8	4.9
32m	16.4	13.6	7.9	4.5	16.8	13.9	8.3	4.6	17.3	14.1	8.4	4.7
34m	15.6	13.1	7.8	4.3	16.0	13.3	8.0	4.4	16.5	13.5	8.1	4.4
36m	14.7	12.2	7.4	4.1	15.3	12.6	7.6	4.1	15.9	13.0	7.7	4.2
38m	13.9	11.4	7.2	3.9	14.5	11.9	7.2	4.0	14.4	12.3	7.4	4.1
40m	13.0	10.7	6.8	3.7	13.4	11.1	7.0	3.8	13.1	11.5	7.0	3.8
42m	12.2	10.1	6.5	3.5	12.2	10.5	6.7	3.6	12.0	10.9	6.8	3.7
44m	11.3	9.5	6.3	3.3	11.2	9.9	6.4	3.4	10.9	10.2	6.5	3.5
46m	10.4	9.0	6.0	3.2	10.2	9.4	6.1	3.3	10.0	9.7	6.2	3.4
48m	9.5	8.5	5.8	3.0	9.4	8.8	5.8	3.1	9.1	9.1	6.0	3.1
50m	8.8	8.1	5.5	2.9	8.6	8.4	5.7	2.9	8.4	8.7	5.7	3.0
52m	8.1	7.7	5.3	2.7	8.0	8.0	5.4	2.8	7.7	8.0	5.5	2.9
54m	7.8/53.0	7.3	5.1	2.6	7.3	7.6	5.2	2.7	7.1	7.4	5.3	2.8
56m		7.0	4.9	2.5	6.8/55.6	7.0	5.0	2.6	6.6	6.8	5.1	2.7
58m		6.6	4.7	2.4		6.5	4.8	2.5	6.0	6.3	4.9	2.5
60m		6.4/58.7	4.6	2.3		6.0	4.6	2.4	5.8/58.3	5.8	4.8	2.4
62m			4.4	2.2		5.7/61.4	4.5	2.2		5.3	4.5	2.3
64m			4.3	2.1			4.3	2.1		5.0/64.0	4.4	2.2
66m			4.2/64.7	2.0			4.2	2.0			4.2	2.1
68m				1.9			4.0/67.3	2.0			4.1	2.0
70m				1.8				1.9			3.9/70.0	1.9
72m				1.8/70.4				1.8				1.8
74m								1.8/73.1				1.7
76m												1.7/75.7
Counterweight (t)	64+20	64+20	64+20	64+20	64+20	64+20	64+20	64+20	64+20	64+20	64+20	64+20
Lines	2	2	1	1	2	2	1	1	2	2	1	1

FIXED JIB LOAD CHART

SCC 1800 Crawler Crane – Fixed Jib Load Charts

No main hook, jib deflection angle: 10°

Unit: (t)

Radius	64m				67m				70m			
	Jib length 13m	19m	25m	31m	13m	19m	25m	31m	13m	19m	25m	31m
16m	25/16.0				16.5/25.6				16.9/25.6			
18m	24.5	18.0/20.4	19.9/11.5		24.7	18.4/20.4			24.9	18.9/20.4		
20m	23.5	19.2	11.3	21.7/6.3	23.7	19.4	20.4/11.4		23.9	19.6	20.8/11.4	
22m	22.6	18.4	10.9	6.2	22.8	18.6	11.0	22.3/6.32	23.0	18.8	11.0	22.8/6.2
24m	21.8	17.6	10.5	6.0	21.9	17.8	10.6	6.0	22.1	18.0	10.6	6.1
26m	20.9	16.9	10.1	5.7	21.2	17.1	10.1	5.7	21.4	17.2	10.1	5.8
28m	20.2	16.1	9.7	5.4	20.3	16.3	9.7	5.4	20.5	16.5	9.7	5.5
30m	19.4	15.6	9.3	5.2	19.4	15.7	9.3	5.2	19.9	15.9	9.3	5.3
32m	18.5	14.9	8.9	4.9	18.2	15.1	8.9	5.0	17.8	15.2	9.0	5.0
34m	16.6	14.3	8.6	4.7	16.4	14.5	8.6	4.8	16.1	14.7	8.6	4.8
36m	15.0	13.8	8.2	4.5	14.7	14.0	8.3	4.5	14.5	14.1	8.3	4.6
38m	13.5	13.3	7.9	4.3	13.3	13.4	8.0	4.4	13.0	13.4	8.1	4.4
40m	12.2	12.6	7.5	4.1	12.0	12.4	7.6	4.2	11.8	12.2	7.7	4.2
42m	11.1	11.4	7.2	3.9	10.9	11.3	7.3	4.0	10.6	11.0	7.4	4.0
44m	10.1	10.5	7.0	3.8	9.8	10.2	7.1	3.8	9.6	10.0	7.1	3.9
46m	9.1	9.5	6.7	3.6	8.9	9.3	6.8	3.7	8.7	9.1	6.9	3.7
48m	8.3	8.7	6.4	3.4	8.2	8.5	6.5	3.5	7.9	8.2	6.6	3.5
50m	7.6	7.9	6.2	3.3	7.4	7.7	6.3	3.4	7.1	7.5	6.3	3.4
52m	6.9	7.2	5.9	3.2	6.7	7.0	6.0	3.2	6.5	6.8	6.1	3.3
54m	6.3	6.6	5.7	3.0	6.1	6.4	5.8	3.1	5.9	6.2	5.9	3.1
56m	5.7	6.1	5.5	2.9	5.6	5.9	5.6	2.9	5.3	5.7	5.7	3.0
58m	5.3	5.5	5.3	2.7	5.1	5.3	5.4	2.8	4.9	5.1	5.5	2.9
60m	4.8	5.0	5.1	2.6	4.6	4.8	5.2	2.7	4.4	4.6	5.0	2.8
62m	4.4	4.6	4.9	2.5	4.2	4.4	4.8	2.6	4.0	4.2	4.6	2.6
64m	3.9	4.2	4.5	2.4	3.8	4.0	4.4	2.5	3.6	3.8	4.2	2.5
66m	3.6	3.9	4.2	2.3	3.4	3.7	4.0	2.3	3.2	3.5	3.8	2.4
68m	3.3	3.5	3.8	2.2	3.1	3.4	3.7	2.2	2.9	3.2	3.5	2.3
70m	3.1/68.8	3.2	3.5	2.1	2.8	3.0	3.3	2.1	2.6	2.9	3.2	2.2
72m		2.9	3.2	2.0	71.5/2.7	2.7	3.0	2.1	2.3	2.6	2.9	2.1
74m		2.7	2.9	1.9		2.5	2.7	2.0	2.1	2.3	2.6	2.0
76m		74.6/2.5	2.7	1.9		2.2	2.5	1.9	74.1/2.0	2.0	2.3	1.9
78m			2.4	1.8		77.2/2.1	2.3	1.8		1.8	2.1	1.8
80m			2.2	1.7			2.1	1.7		79.8/1.6	1.9	1.8
82m			80.5/2.1	1.6			1.9	1.6			1.7	1.7
84m				1.6			83.2/1.7	1.6			1.5	1.6
86m				1.5				1.5			85.8/1.4	1.5
88m				86.3/1.5				1.5				1.3
90m								88.9/1.4				1.2
92m												91.6/1.0
Counterweight (t)	64+20	64+20	64+20	64+20	64+20	64+20	64+20	64+20	64+20	64+20	64+20	64+20
Lines	2	2	1	1	2	2	1	1	2	2	1	1

FIXED JIB LOAD CHART

SCC 1800 Crawler Crane – Fixed Jib Load Charts

No main hook, jib deflection angle: 30°

Unit: (t)

Radius	28m				31m				34m			
	Jib length 13m	19m	25m	31m	13m	19m	25m	31m	13m	19m	25m	31m
14m	18.9/14.3				14.8/18.9				15.3/18.9			
16m	17.8				18.0				18.1			
18m	16.9	18.1/12.7			17.2	18.6/12.7			17.4	19.0/12.7		
20m	15.6	12.5	21.9/7.7		16.1	12.5			16.4	12.5		
22m	14.6	12.0	7.5		15.0	12.1	23.3/7.6		15.4	12.3	23.3/7.6	
24m	13.7	11.4	7.1	25.6/3.8	14.1	11.7	7.2	3.8	14.5	11.7	7.2	
26m	12.9	10.7	6.8	3.7	13.3	11.0	6.9	26.1/3.8	13.7	11.2	6.9	26.6/3.8
28m	12.2	10.0	6.5	3.5	12.6	10.3	6.6	3.5	13.0	10.5	6.7	3.6
30m	11.6	9.4	6.2	3.3	11.9	9.7	6.3	3.4	12.3	9.9	6.3	3.4
32m	11.0	8.9	6.0	3.2	11.4	9.1	6.0	3.2	11.8	9.4	6.1	3.2
34m	10.7	8.4	5.7	2.9	10.9	8.6	5.8	3.0	11.2	8.9	5.9	3.0
36m	10.3	8.0	5.5	2.8	10.5	8.3	5.5	2.9	10.7	8.5	5.6	2.9
38m	9.9/37.8	7.6	5.3	2.7	10.2	7.9	5.4	2.7	10.3	8.1	5.4	2.8
40m		7.4	5.0	2.6	9.9	7.5	5.1	2.6	10.0	7.7	5.2	2.6
42m		7.1	4.9	2.4	40.5/9.7	7.2	5.0	2.4	9.8	7.4	5.0	2.5
44m		6.9	4.8	2.3		7.0	4.8	2.4	43.1/9.8	7.1	4.9	2.4
46m		44.2/6.8	4.6	2.2		6.8	4.6	2.3		6.9	4.7	2.3
48m			4.6	2.1		46.9/6.7	4.6	2.2		6.7	4.6	2.2
50m			4.5	2.1			4.5	2.1		49.5/6.6	4.5	2.1
52m			50.3/4.4	2.0			4.4	2.0			4.4	2.0
54m				1.9			53.0/4.4	1.9			4.3	2.0
56m				1.9				1.9			55.6/4.3	1.9
58m				56.4/1.8				1.8				1.8
60m								59.1/1.8				1.8
62m												61.7/1.8
Counterweight (t)	64+20	64+20	64+20	64+20	64+20	64+20	64+20	64+20	64+20	64+20	64+20	64+20
Lines	2	1	1	1	2	1	1	1	2	1	1	1

FIXED JIB LOAD CHART

SCC 1800 Crawler Crane – Fixed Jib Load Charts

No main hook, jib deflection angle: 30°

Unit: (t)

Boom length Radius	46m				49m				52m			
	Jib length 13m	19m	25m	31m	13m	19m	25m	31m	13m	19m	25m	31m
16m	18.5/17.1				18.5/17.6							
18m	18.0				18.1				18.3/18.1			
20m	17.4	12.5/20.9			17.5	12.5/21.4			17.6	12.5/21.8		
22m	16.7	12.4			16.9	12.4			16.9	12.4		
24m	15.7	12.1	7.4/24.7		16.0	12.2	7.4/25.2		16.3	12.2	7.4/25.6	
26m	14.9	11.8	7.1		15.1	11.8	7.2		15.4	11.8	7.2	
28m	14.1	11.3	6.8	3.7/28.5	14.4	11.4	6.9	3.7/28.9	14.7	11.5	6.9	3.7/29.4
30m	13.5	10.8	6.6	3.5	13.7	11.0	6.7	3.5	14.0	11.2	6.7	3.5
32m	12.9	10.2	6.4	3.3	13.1	10.4	6.4	3.4	13.4	10.6	6.5	3.4
34m	12.2	9.7	6.1	3.2	12.5	9.9	6.2	3.2	12.8	10.1	6.2	3.3
36m	11.7	9.3	5.9	3.1	12.0	9.4	5.9	3.1	12.2	9.7	6.0	3.1
38m	11.3	8.9	5.7	2.9	11.5	9.0	5.8	2.9	11.7	9.2	5.8	3.0
40m	10.8	8.5	5.5	2.8	11.0	8.6	5.5	2.8	11.3	8.8	5.6	2.9
42m	10.5	8.1	5.3	2.7	10.6	8.3	5.4	2.7	10.8	8.4	5.4	2.8
44m	10.1	7.7	5.1	2.6	10.2	7.9	5.2	2.6	10.5	8.1	5.3	2.6
46m	9.8	7.5	5.0	2.4	9.9	7.6	5.0	2.5	10.1	7.8	5.1	2.5
48m	9.4	7.2	4.8	2.4	9.6	7.3	4.9	2.4	9.4	7.5	4.9	2.4
50m	8.9	6.9	4.6	2.3	8.8	7.1	4.7	2.3	8.6	7.1	4.8	2.4
52m	8.2	6.7	4.6	2.2	8.1	6.8	4.6	2.2	7.9	6.9	4.6	2.2
54m	7.6/53.7	6.5	4.4	2.1	7.4	6.5	4.4	2.1	7.2	6.7	4.5	2.1
56m		6.3	4.3	2.0	6.8	6.3	4.3	2.0	6.6	6.4	4.3	2.1
58m		6.1	4.2	2.0	6.6/56.3	6.2	4.2	2.0	6.1	6.2	4.2	2.0
60m		6.0	4.1	1.9		6.0	4.1	1.9	5.8/59.0	6.0	4.1	1.9
62m		5.9/60.1	4.0	1.8		5.7	4.0	1.8		5.5	4.0	1.8
64m			3.9	1.7		5.5/62.7	3.9	1.8		5.1	3.9	1.8
66m			3.9	1.7			3.9	1.7		4.8/65.4	3.8	1.8
68m			3.8/66.2	1.7			3.8	1.7			3.7	1.7
70m				1.6			3.7/68.8	1.6			3.6	1.6
72m				1.6				1.6			3.6/71.5	1.6
74m				1.6/72.3				1.6				1.6
76m								1.5/74.9				1.5
78m												1.5/77.6
Counterweight (t)	64+20	64+20	64+20	64+20	64+20	64+20	64+20	64+20	64+20	64+20	64+20	64+20
Lines	2	1	1	1	2	1	1	1	2	1	1	1

FIXED JIB LOAD CHART

SCC 1800 Crawler Crane – Fixed Jib Load Charts

No main hook, jib deflection angle: 30°

Unit: (t)

Boom length Radius	64m				67m				70m			
	Jib length 13m	19m	25m	31m	13m	19m	25m	31m	13m	19m	25m	31m
20m	18.0/20.0				17.9/20.4				17.9/20.9			
22m	17.3	12.3/23.7			17.4				17.5			
24m	16.8	12.2			16.9	12.2/24.2			17.0	12.2/24.7		
26m	16.3	12.0	7.3/27.5		16.4	12.0			16.5	12.0		
28m	15.5	11.8	7.1		15.7	11.8	7.2/28.0		15.9	11.8	7.2/28.4	
30m	14.9	11.4	6.8	3.6/31.3	15.0	11.5	6.9	3.6/31.7	15.2	11.5	6.9	
32m	14.2	11.1	6.6	3.5	14.4	11.1	6.6	3.5	14.6	11.2	6.7	3.5/32.2
34m	13.6	10.7	6.4	3.4	13.8	10.8	6.5	3.4	13.9	10.8	6.5	3.4
36m	13.1	10.2	6.2	3.2	13.2	10.3	6.2	3.2	13.4	10.5	6.0	3.2
38m	12.5	9.8	6.0	3.1	12.7	9.9	6.0	3.1	12.9	10.1	6.1	3.1
40m	12.0	9.4	5.8	3.0	12.2	9.5	5.8	3.0	12.2	9.6	5.8	3.0
42m	11.5	9.0	5.6	2.8	11.3	9.1	5.7	2.8	11.0	9.2	5.7	2.9
44m	10.5	8.6	5.4	2.7	10.2	8.8	5.5	2.8	10.0	8.8	5.5	2.8
46m	9.4	8.3	5.3	2.6	9.3	8.4	5.3	2.7	9.1	8.5	5.3	2.7
48m	8.6	7.9	5.1	2.5	8.5	8.1	5.2	2.5	8.2	8.2	5.2	2.5
50m	7.9	7.7	4.9	2.4	7.7	7.8	5.0	2.4	7.4	7.9	5.0	2.5
52m	7.2	7.4	4.8	2.3	6.9	7.5	4.8	2.4	6.7	7.4	4.8	2.4
54m	6.5	7.1	4.6	2.3	6.3	7.0	4.7	2.3	6.1	6.8	4.7	2.3
56m	5.9	6.5	4.5	2.2	5.8	6.3	4.5	2.2	5.5	6.1	4.6	2.2
58m	5.4	6.0	4.4	2.1	5.2	5.8	4.4	2.1	5.0	5.6	4.5	2.1
60m	4.9	5.4	4.2	2.0	4.8	5.2	4.3	2.0	4.5	5.1	4.3	2.1
62m	4.5	4.9	4.2	2.0	4.3	4.8	4.2	2.0	4.1	4.6	4.2	2.0
64m	4.1	4.5	4.0	1.9	3.9	4.4	4.0	1.9	3.7	4.2	4.1	1.9
66m	3.7	4.1	3.9	1.8	3.5	4.0	3.9	1.8	3.4	3.8	3.9	1.8
68m	3.4	3.7	3.8	1.7	3.2	3.6	3.8	1.8	3.0	3.4	3.8	1.8
70m	3.1/69.5	3.4	3.7	1.7	2.9	3.3	3.6	1.7	2.7	3.1	3.4	1.8
72m		3.1	3.4	1.7	2.6	3.0	3.3	1.7	2.4	2.8	3.1	1.7
74m		2.8	3.1	1.6	2.5/72.2	2.7	3.0	1.6	2.2	2.5	2.8	1.6
76m		2.5/75.9	2.8	1.5		2.4	2.7	1.5	2.0/74.8	2.2	2.5	1.6
78m			2.6	1.5		2.2	2.4	1.5		2.0	2.3	1.5
80m			2.3	1.5		2.1/78.6	2.2	1.5		1.8	2.0	1.5
82m			2.1/82.0	1.4			2.0	1.4		1.7/81.2	1.8	1.4
84m				1.4			1.8	1.4			1.6	1.4
86m				1.4			1.7/84.7	1.4			1.4	1.4
88m				1.3				1.3			1.3/87.3	1.3
90m				1.3/88.1				1.3				1.3
92m								1.2/90.8				1.1
94m												1.0/93.4
Counterweight (t)	64+20	64+20	64+20	64+20	64+20	64+20	64+20	64+20	64+20	64+20	64+20	64+20
Lines	2	1	1	1	2	1	1	1	2	1	1	1



Quality Changes the World

SANY HEAVY INDUSTRY CO., LTD.

Address: SANY Industrial Park, No. 8 Beiqing Road,

Huilongguan Town, Changping District, Beijing

Service Hotline: +0086-4006-098-318

Email: crd@sany.com.cn

For more information, please visit: www.sanygroup.com

B05S2ENAN1-SCC1800

For our consistent improvement in technology, specifications may change without notice.
The machines illustrated may show optional equipment which can be supplied at additional cost.