

SCC3200A-1

Crawler Crane 320 Tons Lifting Capacity

Quality Changes the World



- Max. lifting capacity: 320t**
- Max. lifting moment: 1820t·m**
- Max. boom length: 86m**
- Max. fixed jib combination: 62m+42m**
- Max. luffing jib combination: 62m+60m**

The parameters, pictures and standard/optional equipment are only for reference in this brochure, the actual machine is based on the effective price list and contract.



Crawler Crane Series
SCC3200A-1

P03

Main
Characteristics

- Product Specification
- Safety Devices

P10

Technical
Parameters

- Major Performance Specifications
- Outline Dimension
- Transport Dimension
- Self-assembly Plan

P22

Cofigurations

- Configurations
- H Configuration
- FJ configuration
- LJ Configuration
- FJh Configuration



SCC3200A-1
SANY CRAWLER CRANE
320 TONS LIFTING CAPACITY

QUALITY CHANGES THE WORLD

Main Characteristics

- Page 04 Product Specification
- Page 08 Safety Devices



Product Specification



Engine

- Model: Chinese Cummins (DCEC) QSL8.9-C325 diesel engine.
- Type: 4-stroke, water-cooled, vertical in-line 6 cylinders, direct injection, turbo-charger, intercooler, complied with European Non-road Tier III Emission Standard and Chinese Non-road Tier III Emission Standard.
- Displacement: 8.9L.
- Rated power: 242kW/2100rpm.
- Max. torque: 1385N·m/1500rpm.
- Cooling system: Temperature-regulated, pressure water circulation system.
- Starter: 24V-5.0kW.
- Radiator: Fin type aluminum plate core.
- Air cleaner: Dry type system with main filter element, safety element and resistance indicator.
- Throttle: Grip type hand throttle, electrically-controlled.
- Fuel filter: Replaceable paper element.
- Batteries: Two 12V×180Ah capacity batteries, connected in series.
- Fuel tank capacity: 1050L.

Electrical control system

- Self-developed SYIC-II integrated control system is adopted with higher integration, precise operation and reliable quality.
- Control system consists of power system, engine system, main control system, LMI system, auxiliary system and safety monitoring system. CAN BUS is used for data communication between controller, monitor and the engine.
- Monitor: The working parameters and status are shown on the monitor, such as the engine speed, fuel volume, engine oil pressure, servo pressure, wind speed, engine working hours, LMI data, ground bearing pressure, control handle function, alarm information, failure self-diagnosis.
- Remote monitoring system: Newly developed APP can collect equipment status at any time anywhere. Online functions such as smart maintenance reminder, failure alarm, construction data feeding, one-click service request, equipment health management are available, which makes the information more transparent and instant.
- Remote control system: This is offered as optional function, all main mechanisms and assisting cylinders can be controlled through remote control box as an optional feature. The monitor can show data of engine and LMI to ensure smarter, easier and safer operation.

Hydraulic system

- Main pumps: Electrically proportionate controlled open variable displacement piston pumps are adopted to provide oil supply for main actuators of main machine.
- Gear pump: One dual-gear pump for oil radiator motor and A/C motor control circuit.
- Control: Main pump adopts load sensitive control; winch motor adopts limitless adjustable piston motor of variable displacement. The operating components are electrical control handle, one dual-travel electrically-controlled pedal to control various actuators proportionally.
- Way of cooling: Air-cooled heat exchanger, fan core and multi-stage cooling.
- Filter: Large flow, high precision filter, with bypass valve and transmitter, which can remind the user to replace the filter element in time.
- Max. pressure of system:
Main/aux. load hoist, boom/jib hoist, swing and travel system: 33Mpa.
Servo pressure: 3.5 MPa.
Hydraulic Tank Capacity:500L .



Product Specification

Main and aux. load hoist mechanism

- Pump and motor: speed regulation through dual displacement pump. Winch counterbalance valve and anti-sliding technology on hook make sure the load lifting and lowering steadily.
- Winch brake: Normally-closed, embedded, wet, spring-loaded disc brake is adopted to brake with spring force and release with oil pressure.
- A variable hydraulic motor drives the planetary gear reducer to control the load lifting and lowering of main hoist winches. A good inching performance is provided. The high-speed mode can realize main and aux. load lifting faster.
- Variable hydraulic motor can realize max. winch speed through automatic adjustment based on electricity flow.
- Choose high-quality spin-resistance wire rope to make sure high safety and longer service life.
- Fold-line machined drum provides high precision and good reliability, making sure the wire rope won't get messy.
- Choose the wire rope lug to make wire rope assembly easier and faster.

Main load hoist mechanism	Rope speed on the outermost work layer	0~120m/min
	Wire rope diameter	26mm
	Wire rope length for main load hoist winch	650m
	Rated single line pull	15t
Auxiliary load hoist mechanism	Rope speed on the outermost work layer	0~120m/min
	Wire rope diameter	26mm
	Wire rope length for aux. load hoist winch	390m
	Rated single line pull	15t

Boom/jib/hoist mechanism

- Including: Boom hoist mechanisms, jib hoist mechanism.
- Drums with folded-line grooves are adopted for all luffing devices. Hydraulic motor drives the planetary gear reducer to realize multiple composite actions and it is equipped with good inching performance.

Boom hoist mechanism	Rope speed on the outermost work layer	130m/min
	Wire rope diameter	28mm
	Wire rope length of boom hoist winch	345m
Jib hoist mechanism	Rope speed on the outermost work layer	100m/min
	Wire rope diameter	20mm
	Wire rope length of jib luffing winch	410m

Swing mechanism

- Swing brake adopts wet, spring loaded, normally-closed brake, and braking through spring force.
- Swing system adopts integrated swing buffer valve and free slipping function, making sure the start and control is steady, and providing excellent inching function.
- Unique swing buffer design makes the braking more stable.
- Swing drive: External engaged swing drive with 360° swing range, and the max. swing speed is 1.0r/min. The max. drive pressure can reach 30MPa.
- Swing lock: Cylinder lock can ensure the upperworks locked securely at four directions after work or during transport.
- Swing ring: Three-row roller bearing.

Product Specification



Cab and control

- Novel operator's cab with fashionable profile, nice interior and large window glass, which can tilt up by 20° to provide panorama view. There are low and high-beam lights, back-view mirror, heater and A/C, radio and other functions. The layout of seat, handles, control buttons are designed with ergonomic principles to make operation more comfortable.
- Cab layout: Integrated 10.4-inch touch screen, programmable smart buttons and optional vibration handle, and man-machine interaction interface are more improved.
- Armrest box: On the left and right armrest box are control handles, electrical switches, emergent stop and ignition switch. The armrest box can be adjusted along with the seat.
- Seat: Multi-way and multi-level floating adjustable seat with unload switch.
- A/C: Cool and heat air; optimized air channels and vents.
- Multiple cameras can present on the monitor at the same time to realize backing video, real-time monitoring of hook working, travel area, winch and wire rope reeving conditions.

Counterweight

- The assembled counterweight blocks are easy for self-assembly and transportation.
- The stacking mode of counterweight tray and blocks is used for easy assembly, disassembly and transportation;

Name	Quantity	Length	Width	Height	Unit weight
Carbody counterweight	2	5.68	1.72	0.582	20
Rear counterweight	14	2.68	2.38	0.49	8
Rear counterweight tray	1	8.06	2.68	0.49	12

Upperworks

- High-strength steel weld framework, with no torsion or deformation. The parts are laid out in the way that is easier for maintenance and service.

Travel drive

- Independent travel drive device is used for each side of crawler. Straight line traveling and steering is driven by travel motor through reducer and drive wheel. Automatic machine direction switch is available.
- The travel system is configured with low and high speed options, which can travel as fast as 1.0km/h.
- Gradeability: 30%.

Travel brake

- Wet, spring loaded, normally-closed brake, braking through spring force and releasing through oil pressure;

Crawler tightening

- The jack is used to push the guide wheel and insert the shim to adjust crawler tension.

Steering system

- The machine is capable of turning with one crawler or in pivot.

Track pad

- High strength alloy cast steel track pad ensure long service life. They are 1200mm wide with a total of 79pads×2.

Track roller

- Maintenance-free track rollers are used.

Jack cylinder

- Jack cylinders are designed to facilitate crawlers removal during job-site transport.



Product Specification

Boom

- The boom is a spatial lattice structure with equal section areas for inserts and tapered section areas for both ends. With tubes welded together, and boom tip and root strengthened with steel plates, it can better transfer the load.
- The length of the boom ranges from 20m base boom to the maximum length 86m.
- Composition: Boom base 12m×1, transitional insert 7m×1, boom top 1m×1, boom insert 6m×1, boom insert 12m×5.
- Boom length varies from basic boom of 20m to max. length of 86m, increasing every 6m. The extension jib is mounted on the boom top.

Fixed jib

- The fixed jib is a spatial lattice structure with equal section areas for inserts and tapered section areas for both ends. With tubes welded together, and jib tip and root strengthened with steel plates, it can better transfer the load.
- Fixed jib length varies from 13m to 42m, increasing by every 6m;
- Composition: Jib top 6.5m, jib base 6.5m, jib insert 6m×1, 11.5m×2.
- The fixed jib length available is 13m, 19m, 24.5m, 30.5m, 36m and 42m; which can be mounted on boom length from 32m to 62m.

Luffing jib

- The luffing jib is a spatial lattice structure with equal section areas for inserts and tapered section areas for both ends. With tubes welded together, and jib tip and root strengthened with steel plates, it can better transfer the load.
- Luffing jib length varies from 24m to 60m, increasing by every 6m.
- Composition: Jib top 6m, jib base 6m, jib insert 6m×2, 12m×3.
- The luffing jib length available is 24m, 30m, 36m, 42m, 48m, 54m, 60m; which can be mounted on boom length from 26m to 62m.

Boom tip sheave block

- Weld structure, connected to the boom through pin, used for aux. hook.

Hook

- There are 7 types of hook blocks are available:

Name of hook block	Max. load weight	QTY	No. of sheaves	Unit weight (t)
300t hook block	300	1	11	5.7
260t hook block	260	1	9	4.8
200t hook block	200	1	9	3.7
160t hook block	160	1	5	3.0
100t hook block	100	1	3	2.1
50t hook block	50	1	1	1.7
16t ball hook	16	1	-	0.9

Note: The above-mentioned is full up configurations, and the actual configurations are based on the order.

Safety Devices



Assembly/Work Mode Control Switch

- Under the assembly mode, over-hoist limit switch, crane boom limit device and load moment limiter do not work, so as to facilitate the installation of crane;
- All safety limit devices work in the work mode.

Emergency Stop

- In emergent situation, this button is pressed down to cut off the power supply of whole machine and all actions stop.

Load Moment Limiter (LMI)

- It is an independent computerized safety control system. LMI can automatically detect the load weight, work radius and boom angle, and present on the display the rated load, actual load, work radius and boom angle. In normal operation, the LMI can make a judgment and cut off automatically if the crane moves towards dangerous direction. It can also perform as a black box to record the lifting information;
- It is composed of monitor, angle sensor and force sensor and other parts.

Over-hoist Limit Switch of Main/Auxiliary Hooks

- Over-hoist protection device comprises of limit switch and weight on boom top, which prevents the hook lifting up too much;
- When the hook lifts up to the limit height, the limit switch activates, buzzer sends alarm, failure indicator light starts to flash, and the hook hoisting action is cut off automatically.

Over-release Limit Switch of Main/Auxiliary Hooks

- It is comprised of activator in the drum and proximity switch to prevent over release of wire rope. When the rope is paid out close to the last three wraps, the limit switch acts, and the system sends alarm through buzzer and show the alarm on the instrument panel, automatically cutting off the winch action.

Function Lock Lever

- If the function lock level is not in work position, all the other handles won't work, which prevents any mis-operation caused by accidental collision.

Boom Hoist Drum Lock

- Pawl lock is used on boom hoist winch, which needs to unlock by switch before operation, in order to prevent mis-operation of handles and ensure safety during nonwork time.

Swing Lock Device

- The electronic lock, normally locked, shall be unlocked before operation, to avoid mis-operation.
- The cylinder locking device can lock the lowerworks and upperworks together, at for positions, front, rear, left and right.

Boom Limit Device

- When the boom elevation angle reaches the max. set limit, the buzzer sounds and boom action cut off. This protection is two-stage control ensured by both LML system and travel switch.

Back-stop Device

- The boom adopts back stop oil cylinder structure, the larger the compression is, the larger the back stop force. The maximum back-stop cylinder is 38t;
- There is a pair of mechanical back-stop device for luffing jib rear strut to prevent mast backing and tension rear strut pendant;
- When the boom to jib angle approaches the smallest angle, there is pneumatic back-stop device to prevent back tipping. The maximum back-stop force is 50t.

Boom Angle Indicator

- Pendulum angle indicator is fixed on the side of boom base close to the cab, so as to provide convenience to the operator.

Hook Latch

- The hook is provided with a baffle to prevent wire rope from falling off.



Safety Devices

Tri-color Load Indicator

- The load indication light has three colors, green, yellow and red, and the real time load status is presented on the display. When the actual load is smaller than 90% of rated load, the green light is on;
- When the actual load is larger than 90% and smaller than 100%, the yellow light is on, the alarm light flashes and sends out intermittent sirens;
- When the actual load reaches 100% of rated load, the red light is on, the alarm light flashes and sends out continuous sirens;
- When the actual load reaches 102% of rated load, the system will automatically cut off the crane operation in dangerous trend.

Audio-visual Alarm

- When the engine is working, the light flashes; when the machine is traveling or swinging, it sends out sirens.

Swing Indicator Light

- The swing indicator light flashes during traveling or swing.

Illuminating Light

- The machine is equipped with the low beam light and high beam light at the front of the cab, illumination light at cab, and other night lights, boom lights to improve the visibility during construction.

Pharos

- Pharos is mounted on the top of boom/jib to indicate the height.

Anemometer

- It is mounted on the top of boom/jib, and displayed on the monitor in the cab.

Electronic Level Indicator

- It displays the tipping angle of crane on the monitor in real time, protecting the machine from dangerous situation.

Seat Interlock

- Put down the function lock lever on the left side of cab seat or if the operator leaves the seat, all control levers will be de-activated to prevent any mis-operation due to accidental collision.

Engine Power Limit Load Adjustment and Stalling Protection

- The controller monitors the engine power to prevent engine getting stuck and stalling.

Engine Status Monitoring

- The engine status will be presented, such as engine coolant temperature, fuel volume, total work hours, engine oil pressure, engine speed, battery charging, voltage.

Monitor System

- Standard remote monitoring system provides functions such as GPS location, GPRS data transfer, machine operation status inquiry and statistics, operation data monitoring and analysis, remote diagnosis of failures.



SCC3200A-1
SANY CRAWLER CRANE
320 TONS LIFTING CAPACITY

QUALITY CHANGES THE WORLD

Technical Parameters

- Page 11 Major Performance Specifications
- Page 12 Outline Dimension
- Page 13 Transport Dimension
- Page 18 Self-assembly Plan

> 10

Major Performance Specifications

Major Performance & Specifications of SCC3200A-1			
Performance Indicators		Unit	Parameter
H Configuration	Max. rated lifting capacity	t	320
	Max. rated lifting capacity	t·m	1820
	Boom length	m	20~86
	Boom angle	°	30°~85°
FJ Configuration	Longest boom + longest fixed jib	m	62+42
	Boom to jib angle	°	10°, 30°
Heavy Fixed Jib	Boom + fixed jib (Shield Application)	m	20+7
	Boom to jib angle	°	22
Luffing jib	Longest boom + longest luffing jib	m	62+60
	Boom luffing angle	°	65°~85°
Speed	Speed of single rope of the main/aux. load hoist (outermost work layer)	m/min	0~120
	Boom hoist winch speed (outermost layer)	m/min	0~130
	Jib hoist winch speed (outermost layer)	m/min	0~100
	Slewing speed	rpm	0~1.0
	Travel speed	km/h	0~1.2/0~0.53 (high and low)
	Gradeability		30%
Engine	Output power	kW	242
	Rated speed	rpm	2100
Transport	Max. transport weight of single part (with main and aux. hoist winches)	t	45
	Transport dimension (L × W × H)	mm	13320×3000×3200
	Average ground pressure	MPa	0.14

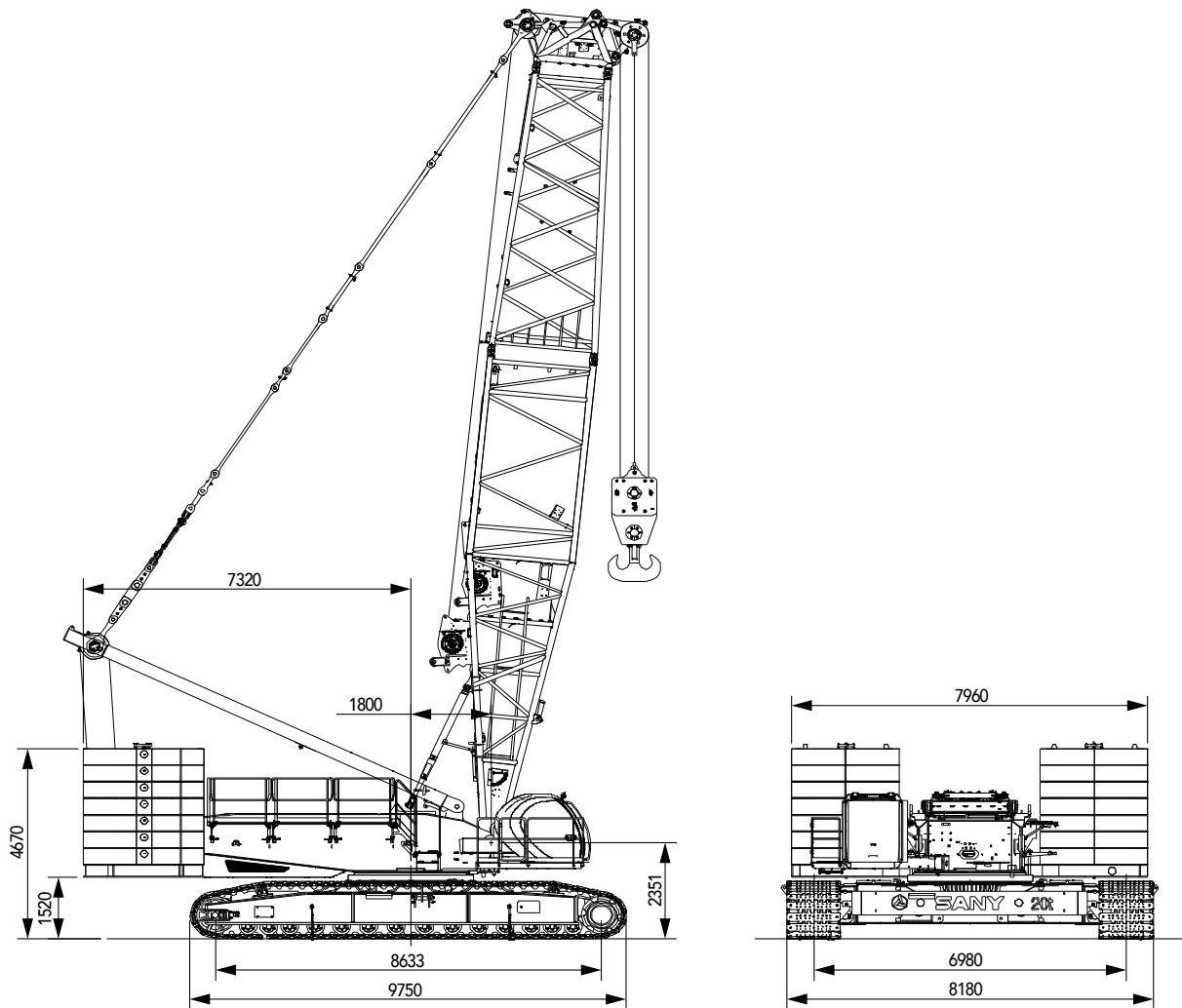
Outline Dimension

Transport Dimension

- 1.The transport dimensions of each part in the table are schematic, not proportional to the real parts. The dimensions are designed value without package considered.
- 2.Weight is designed value that the actual manufactured part may deviate a little.
- 3.The dimensions and weight of each part may change due to product upgrading. The final values are subject to the new product

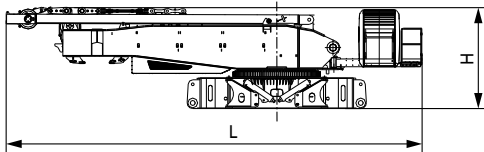

Basic machine		×1
Length (L)		13.32m
Width (W)		3.00m
Height (H)		3.20m
Weight		45.0t

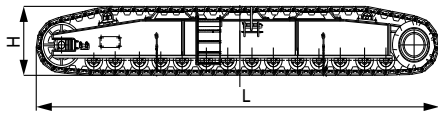

Crawler		×2
Length (L)		9.75m
Width (W)		1.57m
Height (H)		1.42m
Weight		22.93t

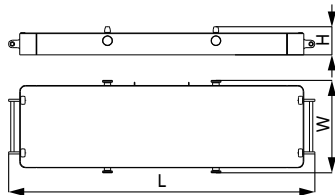

Lower carbody counterweight		×2
Length (L)		5.70m
Width (W)		1.70m
Height (H)		0.52m
Weight		10.0t

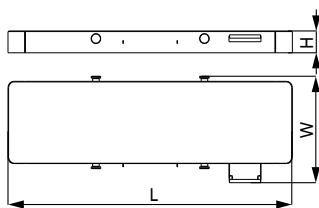

Upper carbody counterweight		×2
Length (L)		5.20m
Width (W)		2.00m
Height (H)		0.40m
Weight		10.0t

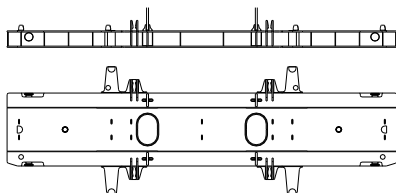

Rear counterweight tray		×1
Length (L)		7.96m
Width (W)		2.70m
Height (H)		0.68m
Weight		12.0t

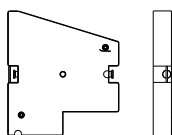

8t counterweight		×14
Length (L)		2.70m
Width (W)		2.41m
Height (H)		0.49m
Weight		8.0t

Transport Dimension

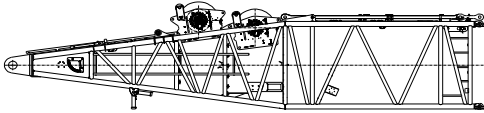

Boom base (with main/aux. winches) ×1

Length (L)	12.30m
Width (W)	2.85m
Height (H)	3.00m
Weight	16.5t

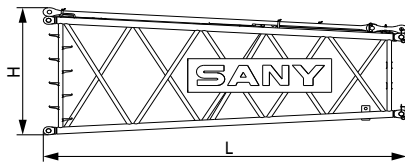

Tapered boom insert ×1

Length (L)	7.18m
Width (W)	2.85m
Height (H)	2.67m
Weight	2.63t

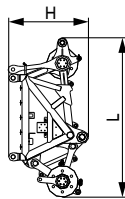

Boom tip (with pulley block) ×1

Length (L)	3.24m
Width (W)	2.07m
Height (H)	1.62m
Weight	3.3t

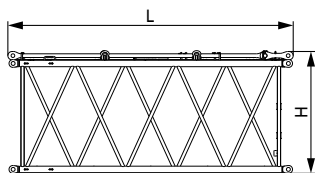

6m boom insert ×1

Length (L)	6.18m
Width (W)	2.85m
Height (H)	2.66m
Weight	1.94t

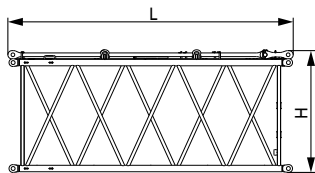

12m boom insert ×5

Length (L)	12.18m
Width (W)	2.85m
Height (H)	2.66m
Weight	3.43t

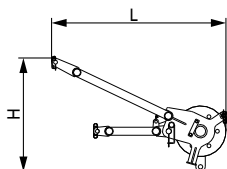

Boom extension ×1

Length (L)	2.20m
Width (W)	0.90m
Height (H)	1.44m
Weight	0.35t

Transport Dimension

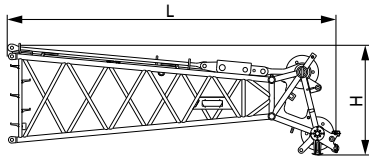

Luffing jib top ×1

Length (L)	6.48m
Width (W)	2.21m
Height (H)	2.14m
Weight	2.18t

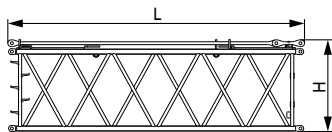

6m luffing jib insert ×2

Length (L)	6.18m
Width (W)	2.21m
Height (H)	1.91m
Weight	1.1t

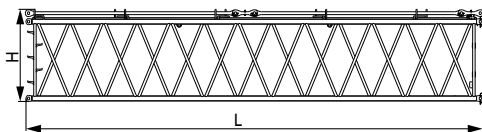

12m luffing jib insert ×3

Length (L)	12.18m
Width (W)	2.21m
Height (H)	1.91m
Weight	2.03t

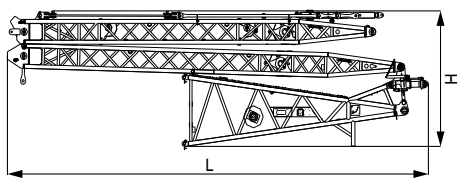

Jib base, front and rear struts ×1

Length (L)	11.50m
Width (W)	2.21m
Height (H)	3.26m
Weight	6.11t

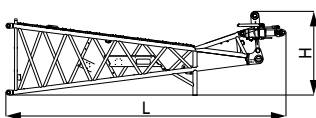

Jib base ×1

Length (L)	6.70m
Width (W)	2.30m
Height (H)	2.00m
Weight	2.04t

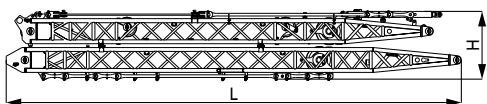

Front/ rear luffing mast ×1

Length (L)	10.80m
Width (W)	2.30m
Height (H)	1.60m
Weight	4.07t

Transport Dimension

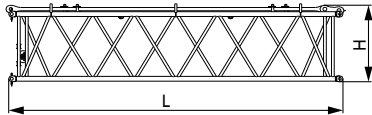

6m fixed jib insert ×1

Length (L)	6.11m
Width (W)	1.50m
Height (H)	1.42m
Weight	0.75t

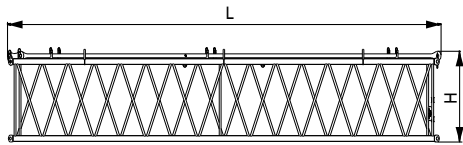

11.5m fixed jib insert ×2

Length (L)	11.67m
Width (W)	1.50m
Height (H)	1.42m
Weight	1.3t

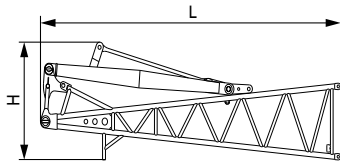

Fixed jib base and strut ×1

Length (L)	6.70m
Width (W)	1.43m
Height (H)	2.00m
Weight	1.7t

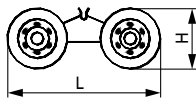

Trolley ×1

Length (L)	2.56m
Width (W)	1.74m
Height (H)	1.00m
Weight	1.0t

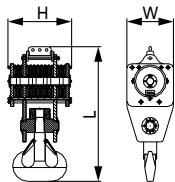

300t hook ×1

Length (L)	2.93m
Width (W)	1.02m
Height (H)	1.39m
Weight	6.2t

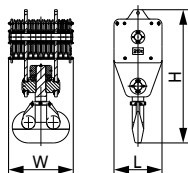

200t hook ×1

Length (L)	0.89m
Width (W)	1.20m
Height (H)	2.49m
Weight	5.2t

Transport Dimension

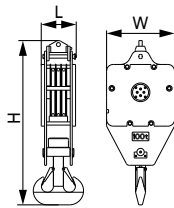

100t hook

×1

Length (L)	0.51m
Width (W)	1.02m
Height (H)	2.48m
Weight	2.3t

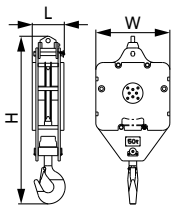

50t hook

×1

Length (L)	0.45m
Width (W)	1.00m
Height (H)	2.30m
Weight	1.7t

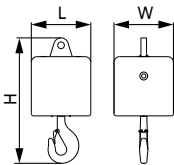

16 hook

×1

Length (L)	0.53m
Width (W)	0.53m
Height (H)	1.10m
Weight	0.9t

Self-assembly Plan

1) Self-assembly of basic machine

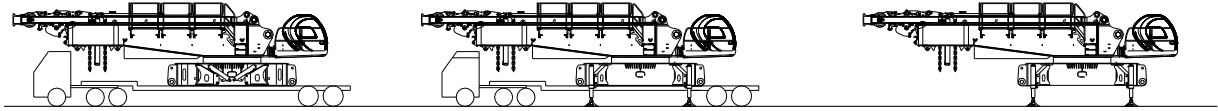

2) Self-assembly of track frame

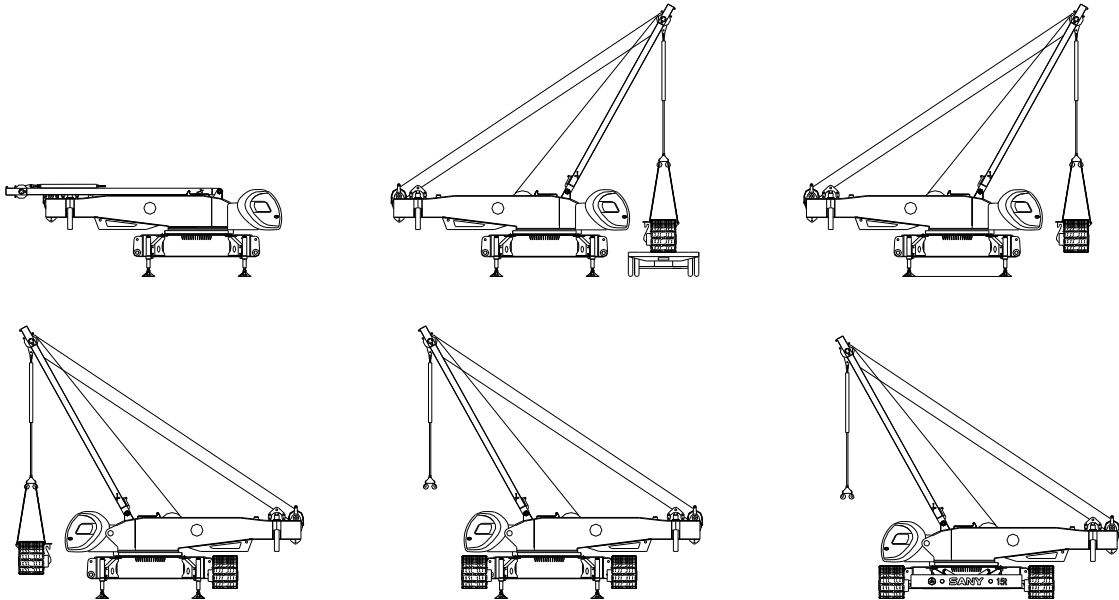

Self-assembly Plan

3) Self-assembly of counterweight and boom base

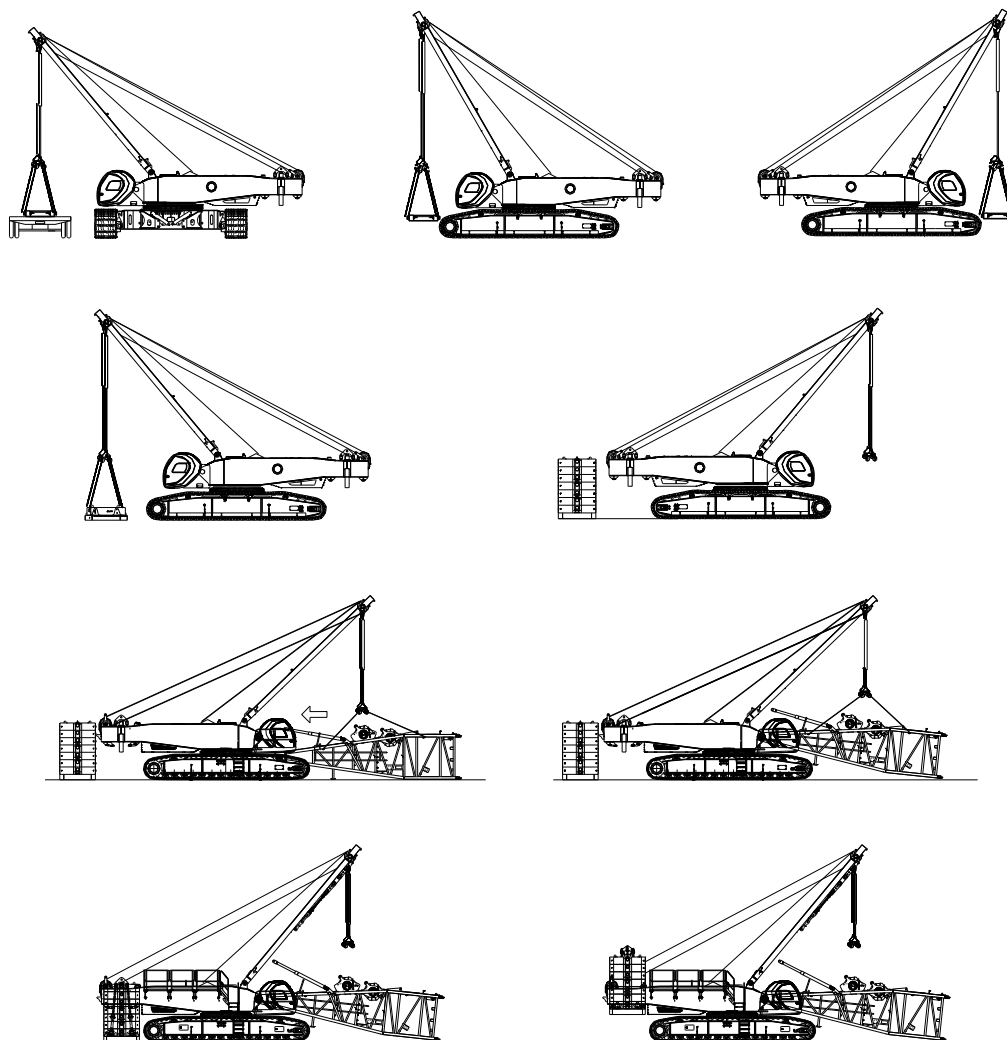

4) Schematics of boom assembly

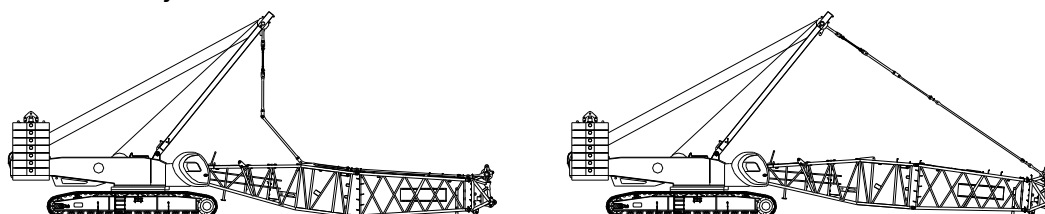

Self-assembly Plan

5) Luffing jib assembly

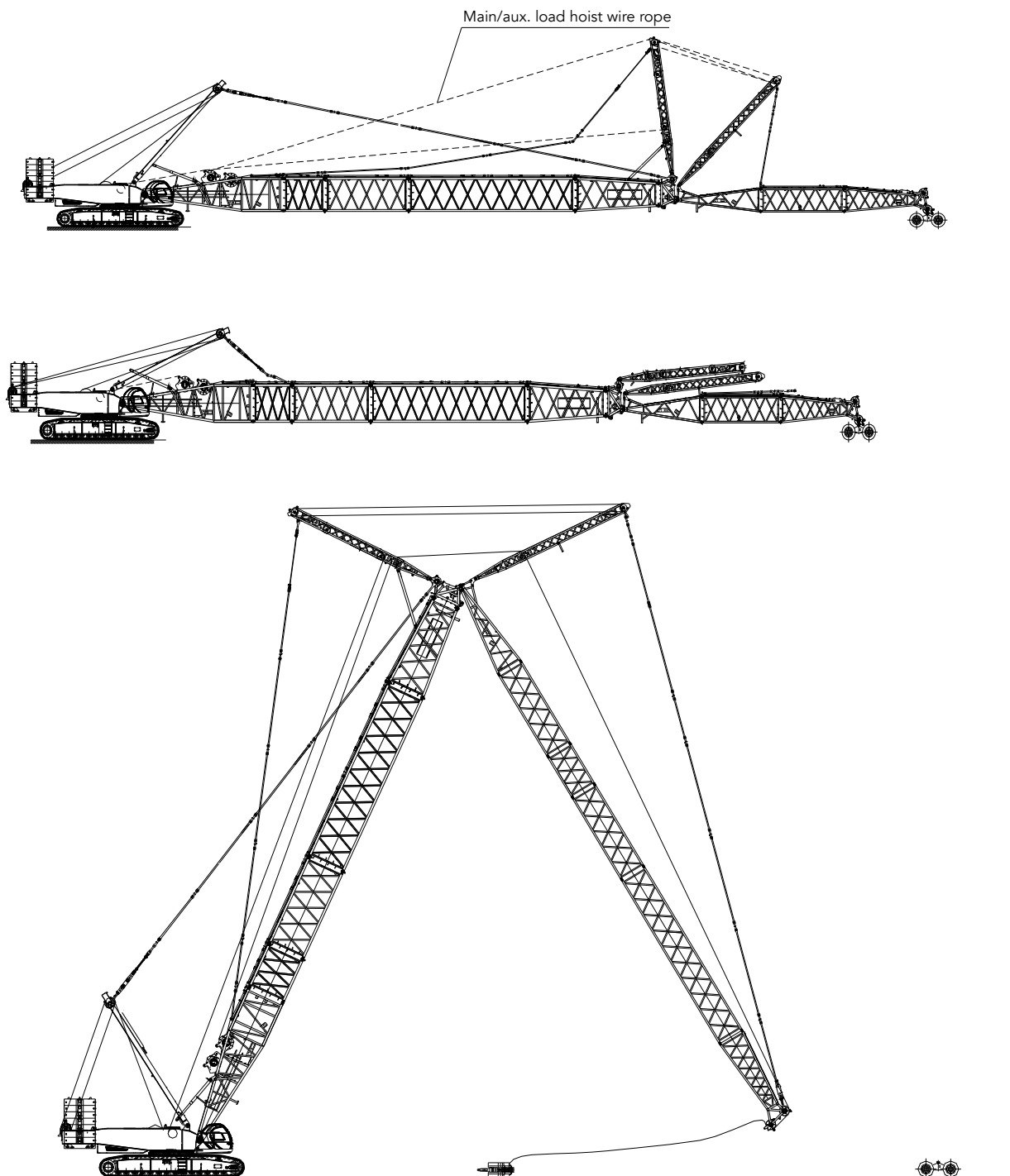

Self-assembly Plan

6) Fixed jib assembly

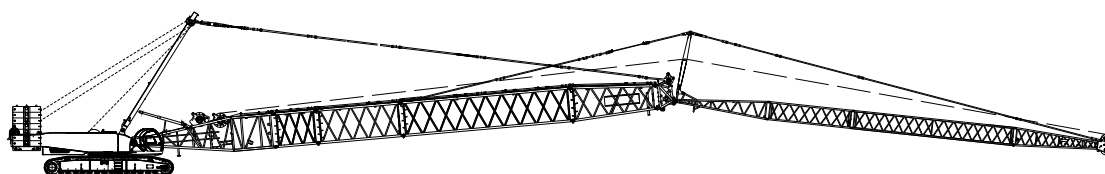
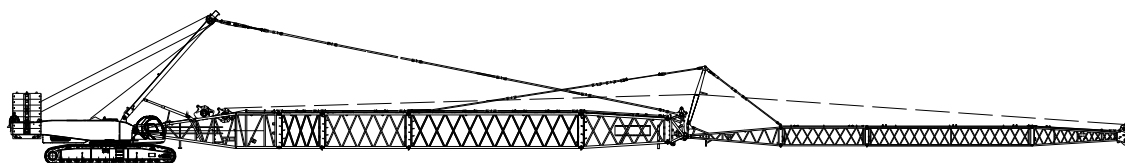



SCC3200A-1
SANY CRAWLER CRANE
320 TONS LIFTING CAPACITY

QUALITY CHANGES THE WORLD

Configurations

- Page 23 Configurations
- Page 24 H Configuration
- Page 27 FJ Configuration
- Page 33 LJ Configuration
- Page 37 FJh Configuration

Boom Combination

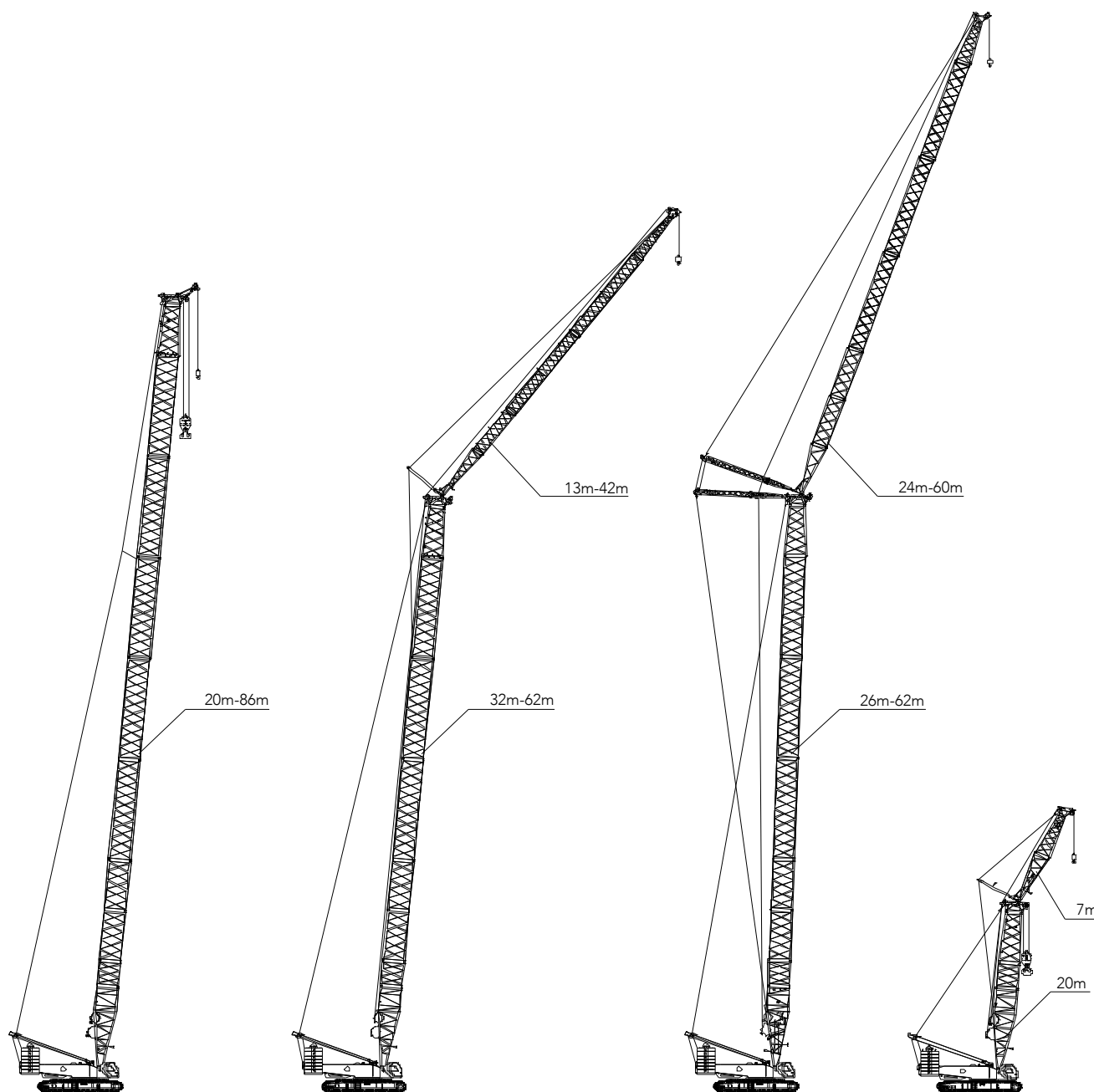

H Configuration
Max. lifting capacity: 320t×5m
Longest boom: 86m

FJ Configuration
Max. lifting capacity: 10m×85.6t
longest boom + longest jib: 62m+42m

LJ Configuration
Max. lifting capacity: 14m×102t
longest boom + longest jib: 62m+60m

FJh Configuration
Lifting capacity:
Aux. hook capacity: 8m×105t
Main hook capacity: 10m×180t
Boom combination: 20m+7m

H Boom Combination

H Boom Combination		
Boom length(m)	Boom insert	
	6 m	12m
20	-	-
26	1	-
32	-	1
38	1	1
44	-	2
50	1	2
56	-	3
62	1	3
68	-	4
74	1	4
80	-	5
86	1	5

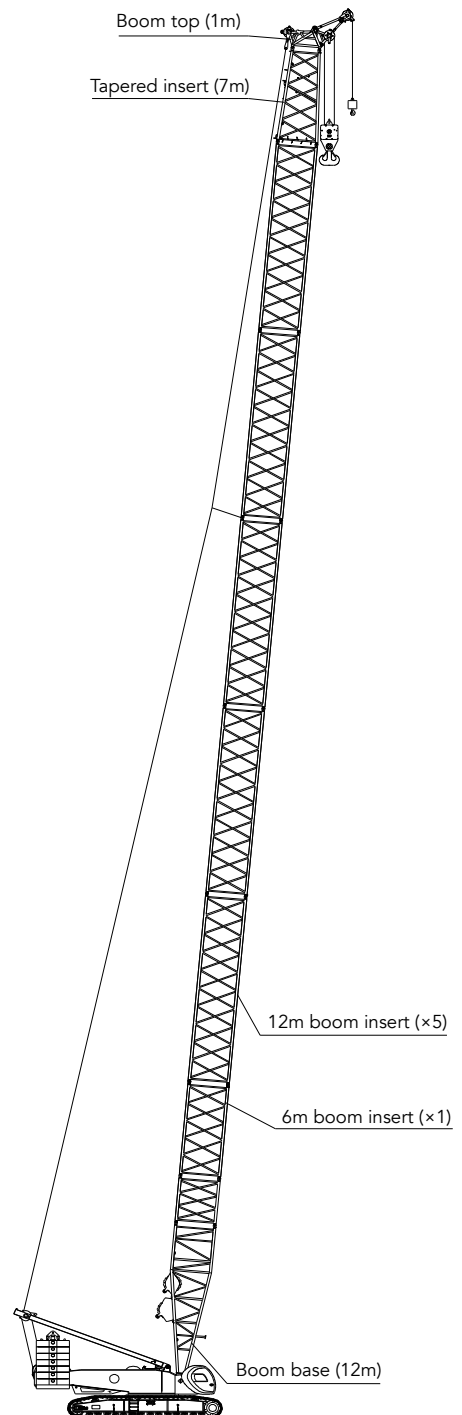

H Working Radius

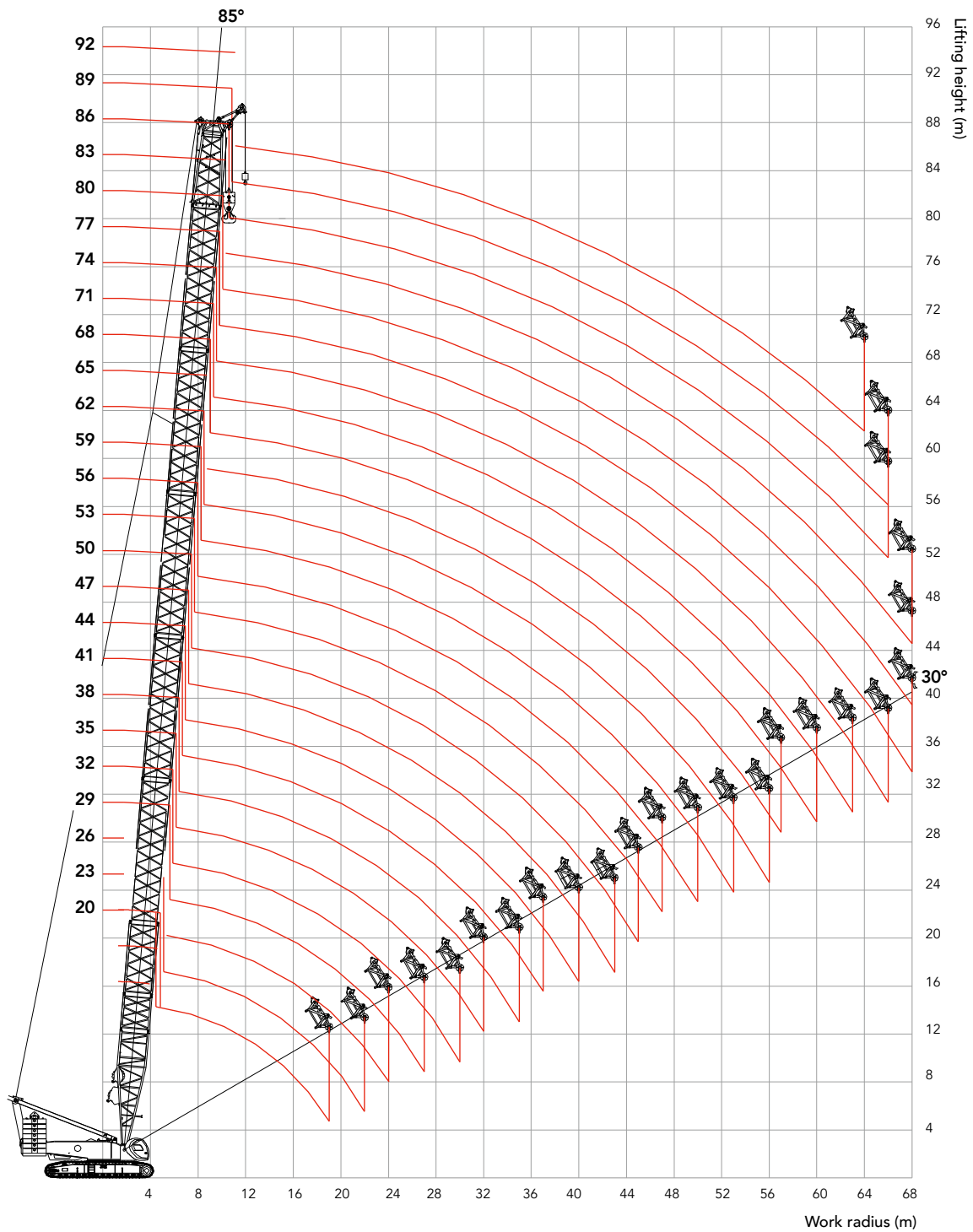

H Load Chart

- 1.The transport dimensions of each part in the table are schematic, not proportional to the real parts. The dimensions are designed value without package considered.
- 2.Weight is designed value that the actual manufactured part may deviate a little.
- 3.The dimensions and weight of each part may change due to product upgrading. The final values are subject to the new product

H Configuration (124+40)															
Boom length 20m~86m Rear counterweight 124t Carbody counterweight 40t															
R (m)	BL(m)	20	26	32	38	44	50	56	62	68	74	80	86	BL(m)	R (m)
5		320													5
6		301	278	259											6
7		255	251	248	228	203									7
8		221	218	215	212	196	177	159							8
9		194	192	190	187	185	170	153	139						9
10		182	172	170	168	165	163	149	135	122	110				10
11		156	155	153	151	149	147	145	131	119	108	97.2	82.7		11
12		142	141	140	138	136	134	132	128	116	105	97	82.4		12
14		120	119	118	117	115	114	112	110	108	100	95.3	81.8		14
16		103	103	102	101	99.8	98.5	97.1	95.6	93.8	91	88.3	81.7		16
18		89.2	89.8	89.8	88.7	87.5	86.4	85.2	83.8	81.9	79.5	77.2	75		18
20			77.5	77.8	77.6	77.3	76.6	75.5	74.3	72.4	70.3	68.3	66.3		20
22			67.9	68.2	68	67.7	67.4	67.1	66.4	64.6	62.7	60.9	59.1		22
24			60.1	60.4	60.3	60	59.7	59.3	58.8	58	56.4	54.7	53.1		24
26				54.1	53.9	53.6	53.3	52.9	52.4	51.9	51	49.5	47.9		26
28				48.7	48.6	48.3	48	47.6	47.1	46.6	46	44.9	43.5		28
30				44.2	44.1	43.7	43.4	43	42.5	42	41.5	40.9	39.6		30
32					40.1	39.8	39.5	39.1	38.6	38.1	37.5	37	36.1		32
34					36.7	36.4	36.1	35.7	35.2	34.7	34.1	33.6	33		34
36						33.4	33.2	32.7	32.2	31.7	31.1	30.6	30		36
38						30.8	30.5	30.1	29.6	29.1	28.5	27.9	27.3		38
40						28.4	28.2	27.8	27.2	26.7	26.1	25.6	24.9		40
42							26	25.6	25.1	24.6	24	23.4	22.8		42
44							24.1	23.7	23.2	22.7	22.1	21.5	20.9		44
46								22	21.5	21	20.4	19.8	19.2		46
48								20.4	19.9	19.4	18.8	18.2	17.6		48
50								19	18.5	18	17.3	16.8	16.1		50
52									17.1	16.6	16	15.5	14.8		52
54									15.9	15.4	14.8	14.2	13.6		54
56									14.8	14.3	13.7	13.1	12.5		56
58										13.2	12.6	12.1	11.4		58
60										12.2	11.6	11.1	10.4		60
62											10.7	10.2	9.5		62
64												9.9	9.3	8.7	64
66													9.1	8.5	66
68														7.8	68
70														7	70
72															72
74															74
76															76

FJ Configuration

FJ Configuration				
Jib length (m)	Jib insert		Boom length(m)	Boom to jib angle
	6 m	11.5 m		
13	-	-	32~62	10°,30°
19	1	-	32~62	10°,30°
24.5	-	1	32~62	10°,30°
30.5	1	1	32~62	10°,30°
36	-	2	32~62	10°,30°
42	1	2	32~62	10°,30°

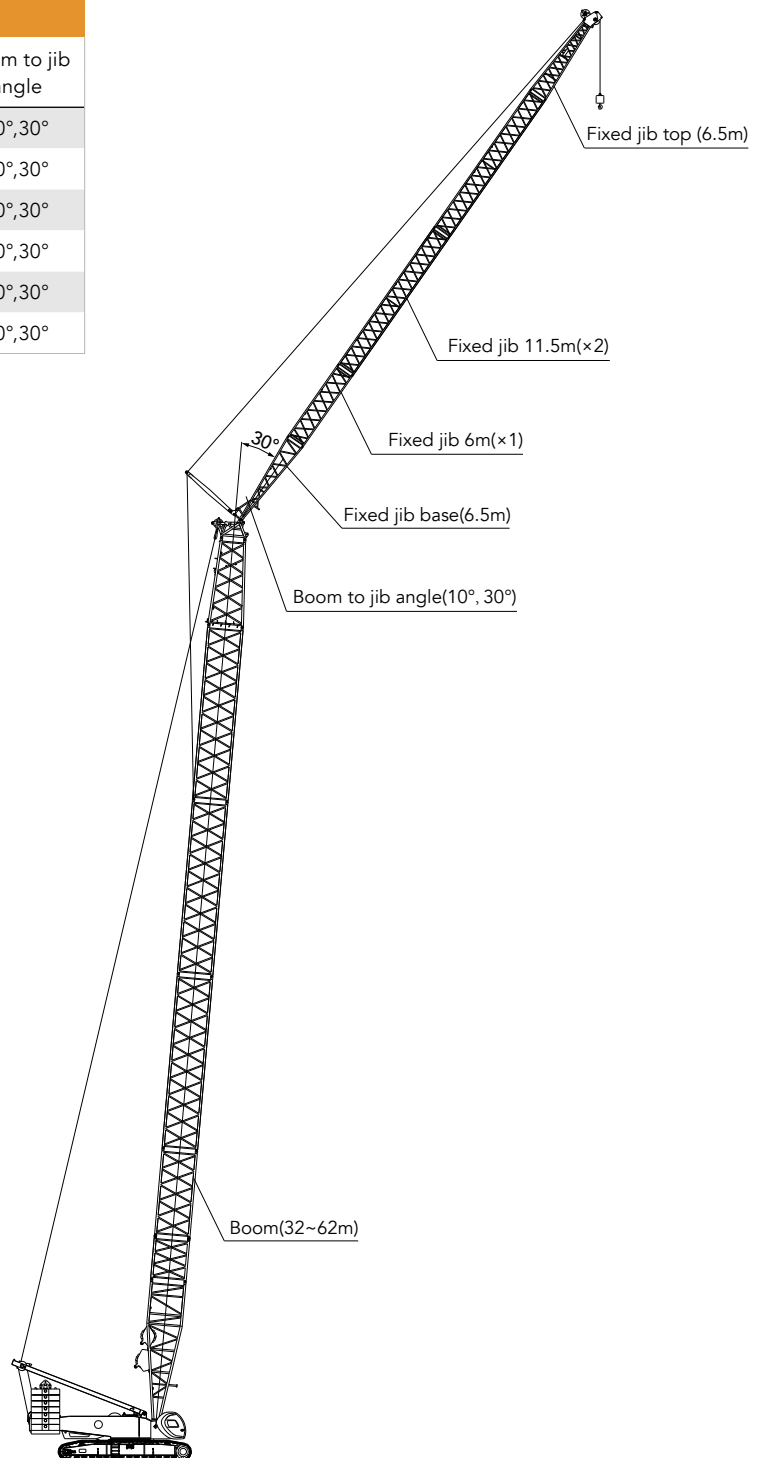

FJ Working Radius

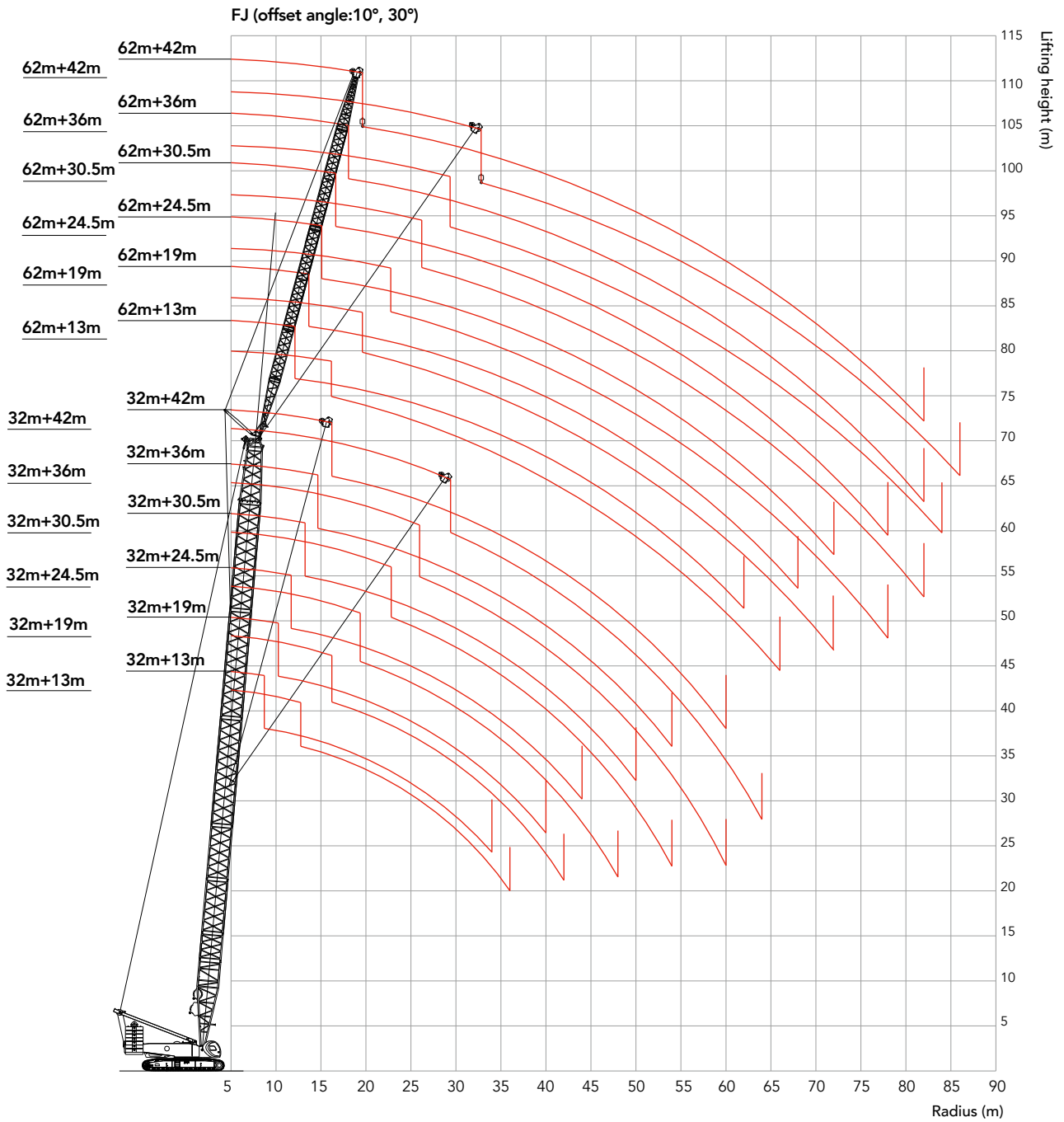

Unit: t

FJ Load Chart

Note:

1. Actual Lifting Capacity shall deduct the weight of hook blocks, lifting devices, and wire ropes reeving between the hooks and boom top from the rate capacity.
2. Rated capacity in the load charts is calculated when the crane is on firm and level ground, and the load lifting is slowly and steadily.

FJ Configuration (without boom hook, rear counterweight 124t+carbody counterweight 40t) 1/4									
Offset angle 10°									
Boom length(m)	32						Boom length(m)		
R (m)	Jib length (m)	13	19	24.5	30.5	36	42	Jib length (m)	R (m)
9									9
10		85.6							10
12		81.5	71.4						12
14		73.2	67.8	59.7					14
16		66.3	61.4	53.4	43.5	32.5			16
18		60.6	55.9	47.4	38.7	31.4	23.3		18
20		55.8	51.4	42.3	34.5	30.0	22.5		20
22		51.2	47.5	38	31	26.9	21.7		22
24		45.2	44.2	34.6	28.4	24.7	21		24
26		40.3	41.2	31.6	26	22.6	19.8		26
28		36.2	37	29.2	24	20.7	18		28
30		32.6	33.5	27.1	22.2	19.1	16.8		30
32		29.6	30.4	25.2	20.7	17.8	15.5		32
34		26.9	27.7	23.5	19.3	16.6	14.4		34
36		24.6	25.4	22.2	18	15.5	13.5		36
38		22.5	23.3	21	17	14.5	12.5		38
40			21.5	19.7	16.1	13.8	11.7		40
42			19.8	18.6	15.1	13	11.1		42
44				17.7	14.4	12.2	10.5		44
46				16.9	13.6	11.6	9.9		46
48				16	13	11	9.4		48
50					12.4	10.5	8.8		50
52					11.8	10	8.3		52
54						9.5	7.9		54
56						9	7.6		56
58						8.6	7.2		58
60							6.9		60
62							6.5		62
64									64
66									66
68									68
70									70
72									72
74									74
76									76
78									78

FJ Load Chart

FJ Configuration (without boom hook, rear counterweight 124t+carboby counterweight 40t) 2/4								
Offset angle 10°								
Boom length(m)		62					Boom length(m)	
Jib length (m)	R (m)	13	19	24.5	30.5	36	42	Jib length (m)
								R (m)
10								10
12								12
14	71.4							14
16	61.8	58	46.7					16
18	54	53.7	46.2	35.5				18
20	47.7	47.5	45.6	35	27.1			20
22	42.4	42.4	42.3	34.4	26.6	20.2		22
24	38	38	38	33.9	26.1	19.8		24
26	34.1	34.2	34.4	33.3	25.7	19.4		26
28	30.8	31	31.1	31.1	25.2	18.9		28
30	27.9	28.1	28.3	28.3	24.7	18.6		30
32	25.3	25.6	25.8	25.9	23.6	18.2		32
34	23	23.3	23.6	23.7	22.3	17.8		34
36	20.9	21.3	21.6	21.7	21	17.5		36
38	19.1	19.4	19.8	19.9	19.9	16.9		38
40	17.4	17.8	18.1	18.3	18.4	15.9		40
42	15.9	16.3	16.6	16.8	17	15.2		42
44	14.5	14.9	15.3	15.4	15.6	14.3		44
46	13.2	13.6	14	14.2	14.4	13.7		46
48	12	12.4	12.8	13	13.3	13		48
50	10.9	11.3	11.8	12	12.2	12.3		50
52	9.9	10.3	10.8	11	11.2	11.3		52
54	9	9.4	9.8	10.1	10.3	10.4		54
56	8.1	8.5	9	9.2	9.4	9.5		56
58	7.3	7.7	8.1	8.4	8.6	8.7		58
60	6.5	6.9	7.4	7.6	7.9	8		60
62		6.2	6.7	6.9	7.2	7.3		62
64		5.5	6	6.2	6.5	6.6		64
66		4.9	5.3	5.6	5.9	6		66
68			4.7	5	5.3	5.4		68
70			4.2	4.4	4.7	4.8		70
72				3.9	4.2	4.3		72
74				3.4	3.7	3.8		74
76				2.9	3.2	3.3		76
78					2.7	2.8		78
80					2.3	2.4		80
82						2		82
84						1.6		84

Unit: t

FJ Load Chart

FJ Configuration (without boom hook, rear counterweight 124t+carbody counterweight 40t) 3/4									
Offset angle 30°									
Boom length (m)		32					Boom length (m)		
R (m)	Jib length (m)	13	19	24.5	30.5	36	42	Jib length (m)	R (m)
9									9
10									10
12									12
14	28.1								14
16	26.5								16
18	25.1	20.8							18
20	23.9	19.7							20
22	22.8	18.7	16.7						22
24	21.8	17.9	15.9	14					24
26	21	17.1	15.1	13.3					26
28	20.2	16.4	14.5	12.7	11.8				28
30	19.5	15.7	13.8	12.2	11.3				30
32	18.9	15.2	13.3	11.6	10.8	10.2			32
34	18.4	14.7	12.8	11.2	10.3	9.7			34
36	17.9	14.2	12.3	10.8	9.9	9.3			36
38	17.5	13.8	12	10.4	9.5	8.9			38
40		13.4	11.6	10	9.2	8.6			40
42		13.1	11.3	9.7	8.8	8.3			42
44		12.8	11	9.4	8.5	8			44
46			10.7	9.1	8.3	7.7			46
48			10.5	8.8	8	7.4			48
50			10.2	8.6	7.8	7.1			50
52				8.4	7.5	6.8			52
54				8.2	7.3	6.6			54
56				8	7.2	6.4			56
58					7	6.1			58
60					6.8	5.9			60
62					6.7	5.7			62
64						5.5			64
66						5.4			66
68						5.2			68
70									70
72									72
74									74
76									76
78									78

Configurations

Unit: t

Unit: t

FJ Load Chart

FJ Configuration (without boom hook, rear counterweight 124t+carbody counterweight 40t) 4/4									
Offset angle 30°									
Boom length (m)		62					Boom length (m)		
R (m)	Jib length (m)	13	19	24.5	30.5	36	42	Jib length (m)	R (m)
10									10
12									12
14									14
16									16
18		27.7							18
20		26.8							20
22		25.9	20.6						22
24		25.1	19.9	17.2					24
26		24.4	19.3	16.7					26
28		23.7	18.7	16.1	13.8				28
30		23.1	18.2	15.6	13.4				30
32		22.5	17.7	15.2	12.9	11.8			32
34		21.9	17.2	14.7	12.6	11.4	10.3		34
36		21.4	16.7	14.3	12.2	11.1	10		36
38		20.3	16.3	14	11.9	10.8	9.7		38
40		18.5	15.9	13.6	11.5	10.5	9.4		40
42		16.9	15.6	13.3	11.2	10.2	9.2		42
44		15.4	15.2	13	11	9.9	8.9		44
46		14.1	14.9	12.7	10.7	9.7	8.7		46
48		12.8	13.7	12.4	10.4	9.4	8.4		48
50		11.6	12.5	12.2	10.2	9.2	8.2		50
52		10.6	11.4	12	10	9	8		52
54		9.6	10.4	11.1	9.8	8.8	7.8		54
56		8.6	9.4	10.2	9.6	8.6	7.6		56
58		7.7	8.5	9.3	9.4	8.4	7.5		58
60		6.9	7.7	8.4	9	8.2	7.3		60
62		6.1	6.9	7.6	8.2	8.1	7.1		62
64			6.1	6.9	7.5	7.9	6.9		64
66			5.4	6.2	6.7	7.3	6.8		66
68			4.7	5.5	6.1	6.6	6.6		68
70				4.8	5.4	6	6.4		70
72				4.2	4.8	5.3	5.8		72
74				3.6	4.2	4.7	5.2		74
76					3.6	4.2	4.6		76
78					3.1	3.6	4.1		78
80						3.1	3.5		80
82						2.6	3		82
84						2.1	2.5		84
86							2.1		86
88							1.6		88

LJ Configuration

LJ Configuration				
Jib length (m)	Jib insert		Boom length (m)	Boom angle
	6 m	12 m		
24	2	-	26~62	65°~85°
30	1	1	26~62	65°~85°
36	2	1	26~62	65°~85°
42	1	2	26~62	65°~85°
48	2	2	26~62	65°~85°
54	1	3	26~62	65°~85°
60	2	3	26~62	65°~85°

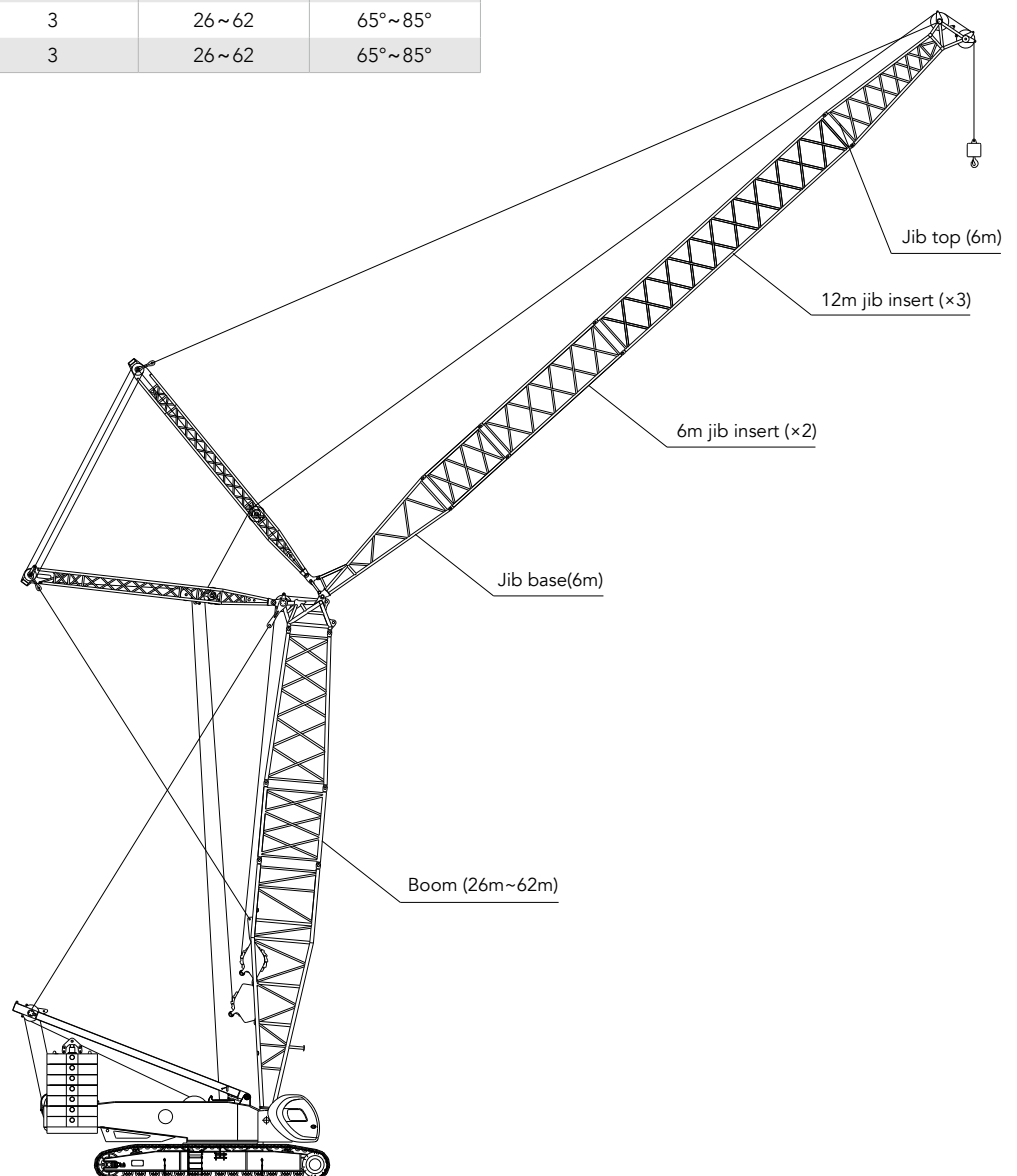

LJ Load Chart

Note:

1. Actual Lifting Capacity shall deduct the weight of hook blocks, lifting devices, and wire ropes reeving between the hooks and boom top from the rate capacity.
2. Rated capacity in the load charts is calculated when the crane is on firm and level ground, and the load lifting is slowly and steadily.

LJ Configuration 1/3

LJ Configuration 1/3										
Boom length 26m Boom angle 85° Jib length 24m~60m Rear counterweight 124t Carbody counterweight 40t										
R (m)	BL(m)	24	30	36	42	48	54	60	BL(m)	R (m)
14		102								14
16		92	89.4							16
18		77.9	77.9	76.6						18
20		67.3	67.8	66.6	66	63.6				20
22		59.1	59.4	58.7	58.5	57.6	50.3			22
24		51.8	52.9	52.2	52.2	51.6	49.8	40		24
26		46	47.6	47.1	46.7	46.3	45.8	39.5		26
28			42.8	42.6	42.7	42	41.5	39		28
30			38.6	38.6	38.7	38.5	37.8	37		30
32			35	35.6	35.4	35.3	34.7	33.9		32
34				32.6	32.5	32.4	31.8	31.4		34
36				29.9	30.1	29.8	29.5	28.9		36
38				27.4	27.8	27.5	27.3	26.7		38
40					25.9	25.5	25.4	25.1		40
44					21.9	22.2	22	21.7		44
48						19.4	19.3	18.9		48
52							16.9	16.6		52
56							14.6	14.6		56
60								12.9		60

Unit: t

LJ Load Chart

LJ Configuration 2/3										
Boom length 38m Boom angle 85° Jib length 24m~60m Rear counterweight 124t Carbody counterweight 40t										
R (m)	BL(m)	24	30	36	42	48	54	60	BL(m)	R (m)
14		100								14
16		98.5	93.1							16
18		90.3	85.5	80.9						18
20		81.1	79.4	75.3	70.3					20
22		73.6	72.7	69.9	66.4	56				22
24		65	64.6	64.9	62.7	55.6	45			24
26		55.9	56.9	57.4	58.1	55.1	44.6	36.1		26
28		50.3	53.4	51.2	52	52.3	44.2	35.7		28
30			47.3	48.6	46.9	47.2	43.7	35.3		30
32			41.7	43.7	42.4	42.9	43	34.9		32
34			38.5	39.3	40.9	39.1	39.3	34.5		34
36				35.3	37.3	35.7	36	33.1		36
38				33.6	33.9	34.9	33.1	31.3		38
40				29.3	30.9	32.1	30.5	29.6		40
44					27	27.1	27.8	26.2		44
48						22.6	23.8	24.1		48
52						19.6	20.2	20.9		52
56							18.2	17.9		56
60								16.5		60
62								15		62

LJ Load Chart

LJ Configuration 3/3										
Boom length 62m Boom angle 85° Jib length 24m~60m Rear counterweight 124t Carbody counterweight 40t										
R (m)	BL(m)	24	30	36	42	48	54	60	BL(m)	R (m)
16		76.3								16
18		73.1	64.1							18
20		69.3	62	53.9						20
22		64.4	59.6	52.5	45.4					22
24		60.3	57.1	50.8	44.5	38.3				24
26		56.3	53.8	49.1	43.4	37.6	32.1			26
28		52.4	50.7	47.3	42.2	36.8	31.6	26.7		28
30		49.1	47.8	45.5	40.9	36	31.1	26.4		30
32			44.9	42.9	39.7	35.2	30.5	26		32
34			42.1	40.7	38.4	34.3	29.9	25.6		34
36			39.6	38.5	36.9	33.3	29.3	25.1		36
38				36.3	35.1	32.3	28.6	24.7		38
40				34.4	33.4	31.4	27.9	24.2		40
44					30.2	29.2	26.5	23.3		44
48					24.7	26.6	25.1	22.2		48
52						22.7	22.6	21.1		52
56							20.6	19.7		56
60								17.8		60
64								15.5		64

FJh Configuration

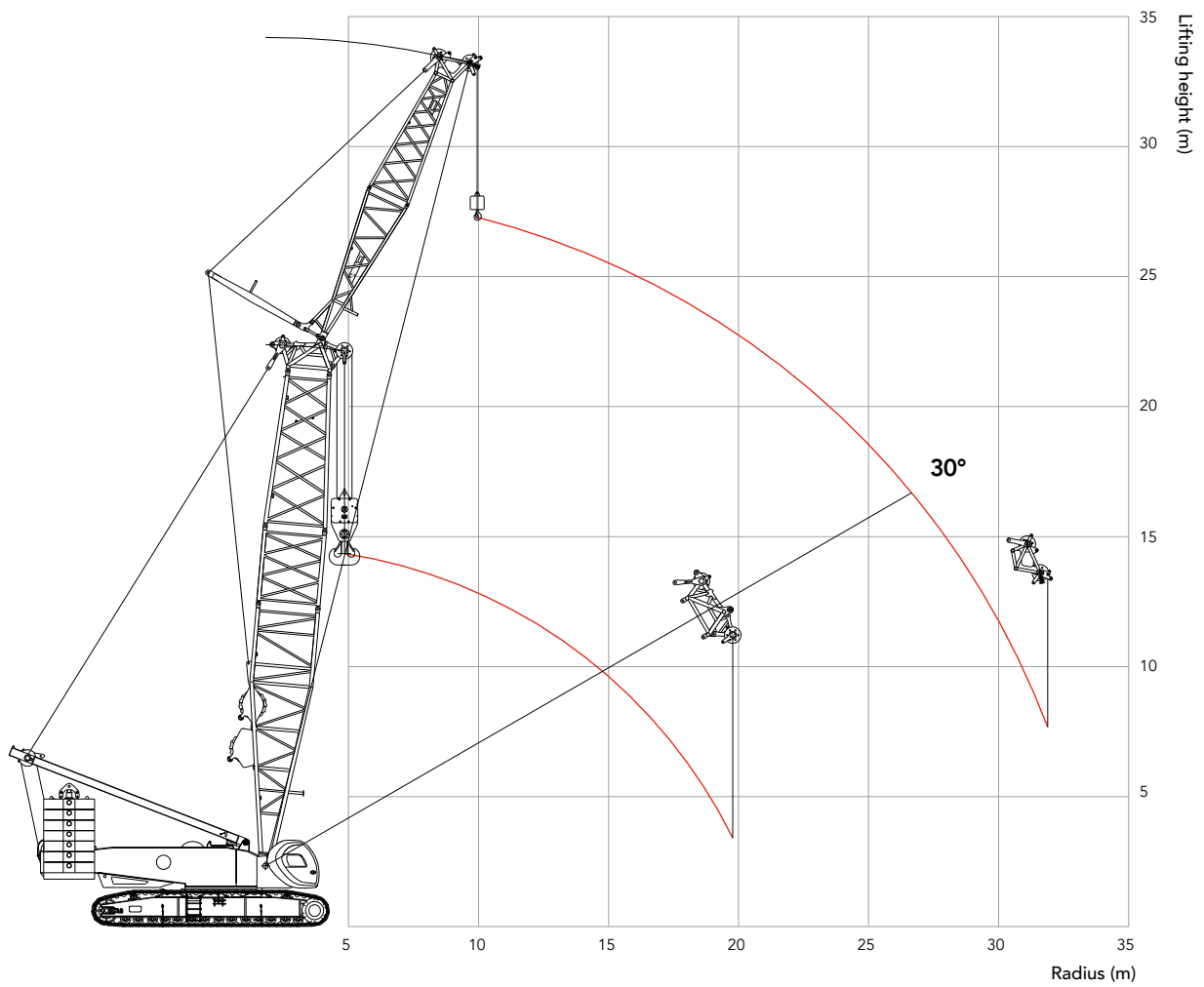

FJh Load Chart

Note:

1. Actual Lifting Capacity shall deduct the weight of hook blocks, lifting devices, and wire ropes reeving between the hooks and boom top from the rate capacity.
2. Rated capacity in the load charts is calculated when the crane is on firm and level ground, and the load lifting is slowly and steadily.

FJh Configuration			
Boom to jib angle 22° Rear counterweight 124t Carbody counterweight 40t			
Boom length 20m, Jib length 7m			
Radius(m)	Main hook (no load on aux. hook)	Aux. hook(no load on main hook)	Radius(m)
5	300		5
6	290		6
7	250		7
8	215	105	8
9	190	98	9
10	180	96	10
11	140	91	11
12	135	88	12
14	110	74	14
16	85	67	16
18	70	62	18
20		57	20
22		50	22
24		44	24
26		39	26
28			28
30			30



Zhejiang Sany Equipment Co.,LTD

SANY Crawler Crane Industrial Park, No. 2188 Daishan Road, Wuxing District, Huzhou City,
Zhejiang Province, P. R. China Zip 313028
Consulting sanycrane@sanygroup.com (Crane BU) / crd@sany.com.cn (IHQ)
After-sales Service 0086-400 6098 318

Reminder:

Any change in the technical parameters and configuration due to product modification or upgrade may occur without prior notice.
The machine in the picture may include additional equipment. This brochure is for reference only, and goods in kind shall prevail.
Copyright at SANY. No part of this brochure may be copied or used for any purpose without written approval from SANY.

© Edited in April 2023

